



ROYAL
ACADEMY
of
ENGINEERING

The Cost of Generating Electricity

A study carried out by PB Power for
The Royal Academy of Engineering



The Costs of Generating Electricity

The Costs of Generating Electricity

© The Royal Academy of Engineering

ISBN 1-903496-11-X

March 2004
Published by
The Royal Academy of Engineering
29 Great Peter Street, Westminster, London, SW1P 3LW

Telephone 020 7222 2688 Facsimile 020 7233 0054
www.raeng.org.uk

The Royal Academy of Engineering is a Registered Charity (No. 293074)

£50.00

Foreword

In order to make sensible decisions about energy policy for the UK, policy makers need to be able to compare the costs and benefits of different types of electricity generating technologies on a like for like basis. Unfortunately, the UK electricity market is complex. The relationship between the cost of generating electrical power from various sources and the price that consumers pay is blurred by direct and indirect subsidies, market mechanisms, transmission and distribution costs. The true costs of generating electrical power are often obscured by commercial sensitivities and competing claims make the determination of sensible energy policy difficult and often imprecise.

The Royal Academy of Engineering has taken a keen interest in energy policy and has often been concerned about the lack of clarity between competing claims over what is the best mix of generation and how the electricity market should be manipulated to achieve the aims of the Governments current energy policy. To help improve understanding, the Academy has attempted to compare the costs of generating electricity from a number of different technologies in an even-handed and dispassionate manner and commissioned PB Power to carry out a study.

The complex financial structures of commercial projects mean that it is often impossible to compare the capital costs of generating plant in a meaningful manner. This study has taken what we know to be the actual costs of building, maintaining and running various types of power station in the UK and derived costs of producing electricity by using a common financing model with a nominal discount rate of 7.5%. It compares new build power stations on a level playing field and examines their sensitivities to emissions costs and fuel prices. The figures presented here are therefore indicative rather than predictive. However, unlike many other compilations of costs, they compare like with like and therefore will be of immense use to policy makers.

The issues to be addressed when considering an energy policy include: security of supply, environmental impact, national competitiveness and social concerns. Each technology examined in this study has its own set of characteristics that are valued to more or lesser extents depending on the context and which have a bearing on four issues above. Hence, the mix of generation cannot and should not be determined solely by cost, but a rigorous understanding of those costs will enable policy makers to understand the levels of subsidy or market manipulation that is required to give a desired outcome. Furthermore, those market mechanisms and subsidies should relate directly to the particular form of generation and the perceived benefit rather than being smoothed across the system, giving rise to cross subsidies.

This examination of the costs of generating electricity is a foundation upon which discussion about future energy policy including subsidies and market mechanisms can be based.

Mr Phil Ruffles CBE RDI FEng FRS

Chairman of the Study Steering Group

CONTENTS

FOREWORD	3
CONTENTS	4
list of abbreviations	5
1. SUMMARY	7
1.1 Aims	7
1.2 Results	7
2. METHODOLOGY	12
2.1 The problem with electricity...	12
2.2 Relevant costs	13
2.3 Intermittency	14
2.3.1 Extent of wind intermittency	14
2.3.2 Cost of standby generation	15
2.4 Selection of technologies	16
3. FUELS	17
3.1 Overview	17
3.2 Fossil fuel prices	18
3.3 Biomass fuels	20
4. ENVIRONMENTAL CONSIDERATIONS	21
4.1 Legislation	21
4.2 Abatement of emissions	22
4.2.1 Sulphur dioxide	22
4.2.2 Oxides of nitrogen	22
4.2.3 Particulates	22
4.3 Carbon costs	23
ANNEX 1 – TECHNOLOGIES	25
A.1 Coal-fired PF	27
A.2 Fluidized-bed combustion	29
A.2.1 Coal-fired CFB	30
A.2.2 Biomass-fired BFB	31
A.3 Coal-fired IGCC	33
A.4 Gas turbines	35
A.4.1 Gas-fired OCGT	35
A.4.2 Gas-fired CCGT	37
A.5 Nuclear fission	40
A.6 Wind turbines	43
A.6.1 Onshore	43
A.6.2 Offshore	45
A.7 Wave and Marine technologies	46
ANNEX 2 - THE ROYAL ACADEMY OF ENGINEERING ENERGY PORTFOLIO	49

LIST OF ABBREVIATIONS

ACR	Advanced CANDU Reactor
AGR	Advanced Gas-Cooled Reactors
BAT	best available techniques
BFB	bubbling fluidized-bed
CO ₂	carbon dioxide
CFB	circulating fluidized-bed
CCGT	combined-cycle gas turbine
DTI	Department of Trade and Industry
ELV	emissions limit value
ETS	Emissions Trading Scheme
EIA	Energy Information Administration
EPC	engineer, procure and construct
EEC	European Economic Community
EPR	European Pressurised water Reactor
EU	European Union
FGD	flue gas desulphurisation
GT	gas turbine
GJ	gigajoules
HRSG	heat recovery steam generator
Hz	Hertz (frequency, cycles per second)
HTR	high temperature reactor
HHV	higher heating value
IGCC	integrated gasification combined cycle
IPPC	integrated pollution prevention and control
IDC	interest during construction
IEA	International Energy Agency
JESS	Joint Energy Security of Supply Working Group
kW	kilowatt
kWh	kilowatt-hour
LCPD	large combustion plant directive
LNG	liquefied natural gas
LHV	lower heating value
MCT	Marine Current Turbines
MIT	Massachusetts Institute of Technology
MW	megawatt
MW _{th}	megawatt thermal
MOX	mixed oxide
NAQS	National Air Quality Strategy
NERP	National Emissions Reduction Plan
NO ₂	Nitrogen Dioxide
NEA	Nuclear Energy Agency
OCGT	open-cycle gas turbine
O&M	operation and maintenance
OECD	Organisation for Economic Co-operation and Development
OWC	oscillating water column
NO _x	oxides of nitrogen
PBMR	pebble bed modular reactor
PIU	Performance and Innovation Unit
PV	photovoltaic
PPC	pollution, prevention and control
PPA	power purchase agreement
PFBC	pressurised fluidized-bed
PWR	pressurised water reactor
PF	pulverised fuel
SCR	selective catalytic reduction
SNCR	selective non-catalytic reduction
ST	steam turbine
SO ₂	sulphur dioxide

1. SUMMARY

1.1 Aims

PB Power has been appointed by the Royal Academy of Engineering to undertake a study of the costs of generating electricity. The aim of the study is to provide decision makers with simple, soundly based, indicators of cost performance for a range of different generation technologies and fuels.

There are, of course, almost limitless fuel and technology combinations and, as such, the focus of this particular study is to examine the costs of well-established technologies appropriate to the UK, as well as those which are likely to become established (or 'bankable') over the next fifteen to twenty years.

It is important to draw a distinction between the cost of generating electricity and the price for which it is sold in the market. This study is solely concerned with generation costs and not with electricity prices.

With a mature electricity supply industry, as found in the UK, there is the option to extend the life of an existing power station beyond its original design life with selected rehabilitation works and/or retrofitting of additional equipment for improved performance. This study does not examine the merits of extending the life of existing plants; its principal objective is to compare the costs of generating electricity from new plants, appropriate to the UK system, which are compliant with existing and proposed environmental legislation.

All generation technologies exhibit some degree of 'intermittency' or 'unpredictability' to a greater or lesser extent. The level of intermittency, however, for certain renewable generation technologies such as wind turbines, is generally higher than for more conventional forms owing to the unpredictable nature ('fickleness') of the energy source in the wind itself. One of the challenges faced by this study is to derive a robust approach to compare directly the costs of intermittent generation with more dependable sources of generation on a like-for-like basis.

1.2 Results

The cost of generating electricity, as defined within the scope of this study, is expressed in terms of a unit cost (pence per kWh) delivered at the boundary of the power station site. This cost value, therefore, includes the capital cost¹ of the generating plant and equipment; the cost of fuel burned (if applicable); and the cost of operating and maintaining the plant in keeping with UK best practices.

Within the study, however, the 'cost of generating electricity' is deemed to refer to that of providing a dependable (or 'firm') supply. For intermittent sources of generation, such as wind, an additional amount has been included for the provision of adequate standby generation.

¹ *With the exception of nuclear, the analysis assumes that decommissioning is cost neutral. The capital cost estimate for nuclear plant includes an allowance for the costs of decommissioning.*

The findings of this study are summarised in Figure 1.1, which illustrates the present-day costs of generating electricity from different types of technology appropriate to the UK:

Figure 1.1 – Cost of generating electricity (pence per kWh) with no cost of CO₂ emissions included.

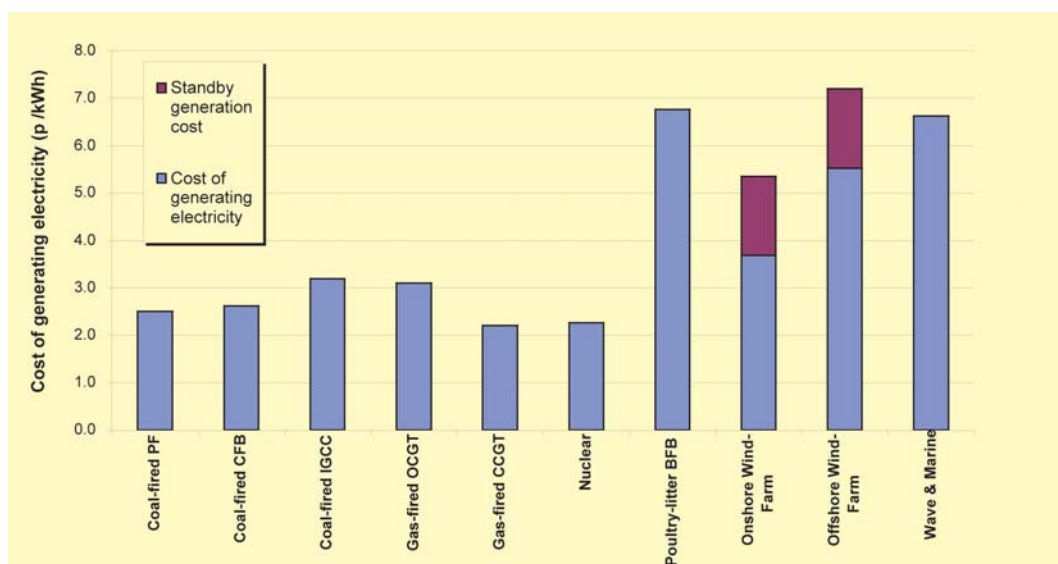

For base-load operation, i.e. those plants which are operated continuously, the cheapest way to generate electricity in the future from new plant, i.e. ignoring rehabilitation of existing plant, is by constructing combined-cycle gas turbine (CCGT) plant designed to burn natural gas.

Table 1.1 summarises the cost of generating electricity for the different ‘base-load’ plants considered by this study.

Gas-fired CCGT	2.2
Nuclear fission plant	2.3
Coal-fired pulverised-fuel (PF) steam plant	2.5
Coal-fired circulating fluidized bed (CFB) steam plant	2.6
Coal-fired integrated gasification combined cycle (IGCC)	3.2

For peaking operation, i.e. generating for limited periods of high demand and providing standby capacity, open-cycle gas turbines (OCGT) fired on natural gas are the most appropriate new plant candidates. OCGT is ideally suited for the role of peaking duty, which requires flexibility, reliability and can be started quickly should the need arise. We estimate that the cost of a gas-fired OCGT generation will be about 3.1 pence per kWh if operated continuously. However, the average cost will rise to about 6.2 pence per kWh if only operated for limited periods of time consistent with peaking duty, i.e. for only 15 per cent of the time, say.

Renewables are generally more expensive than conventional generation technologies. This is due in part to the immaturity of the technology and the more limited opportunity to take advantage of cost savings brought about by economies of scale usually associated with more traditional fossil-fuel types of generation. In addition, fluctuations in the energy source itself may limit the output of generation available from these technologies and, thus, raise the unit costs of the generator on two counts:

- as capacity factor² falls, unit costs of generation rise;
- additional, fast response, standby generating plant may have to be provided to maintain system security as the energy source fluctuates.

Table 1.2 summarises the cost of generating electricity, with and without the additional cost of standby generation, from the selection of renewable technologies considered by this study.

Table 1.2 - Cost of generating electricity for selected renewables (pence per kWh)

	Without standby generation	With standby generation
Poultry litter-fired bubbling fluidized bed (BFB) steam plant	6.8	6.8
Onshore wind farm	3.7	5.4
Offshore wind farm	5.5	7.2
Wave and marine technologies ³	6.6	6.6

Although the fuel component of electricity may represent as much as 70 per cent of the total cost of production, deriving a detailed forecast of future fuel prices was outwith the scope of this study. In order to compare the costs of different fuels used in electricity generation, we have taken a pragmatic view of historical prices and the key drivers affecting fuel prices moving forward to derive reasonable benchmarks from which to perform sensitivity analyses.

Figure 1.2 illustrates the effect on the cost of generating electricity given a change of ± 20 per cent in fuel price, where the base cost of coal is £30 per tonne and natural gas is 23 pence per therm.

²'capacity factor' is an operational term to represent the extent to which the generator is producing electricity over a period, e.g. a year. Wind turbines have typical capacity factors of 25-45 per cent whilst large coal or nuclear plants may have capacity factors in excess of 90 per cent when operating on base-load.

³The additional cost of standby generation for wave and marine technologies has not been included because only low levels of penetration are expected within the study horizon.

Figure 1.2 –Effect of ± 20% change in fuel price on the cost of generating electricity

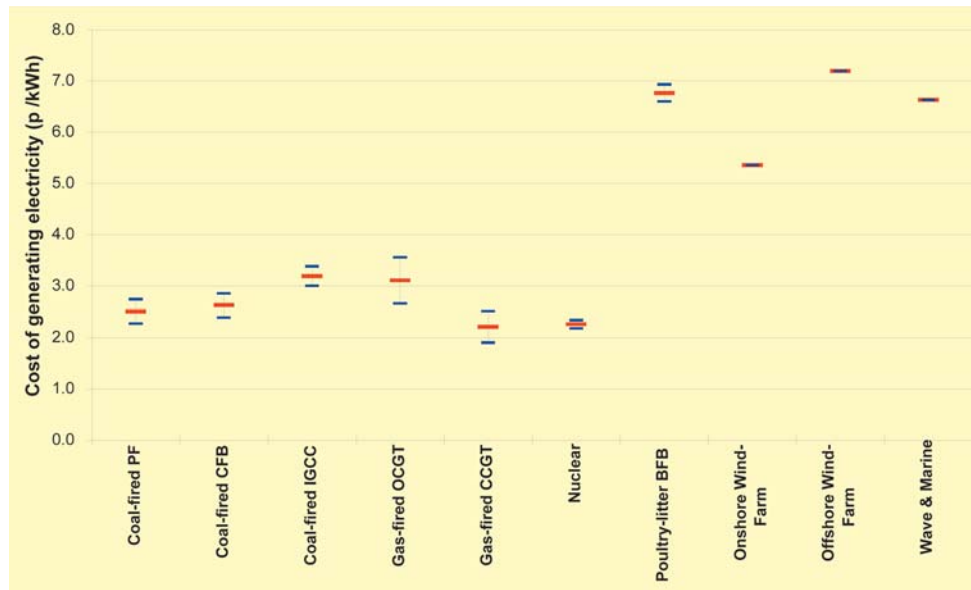

At the time of writing this report, no firm commitment has been given by the Government on how carbon dioxide (CO₂) emission allowances will be allocated to new entrant generation plant for the period 2005 to 2007. In view of this uncertainty, a conservative approach has been adopted by the study to burden 100 per cent of the output from fossil-fuelled generation with a notional cost, calculated in terms of £ per tonne of CO₂ released. For the purposes of this study, a range of values between zero and £30 per tonne was used, where the upper limit reflects the reported cost of CO₂ sequestration.

Figure 1.3 illustrates the potential increase in generating costs brought about by the introduction of carbon emission allowances.

Figure 1.3 – Cost of generating electricity with respect to carbon dioxide emission costs. (Zero to £30 per tonne)

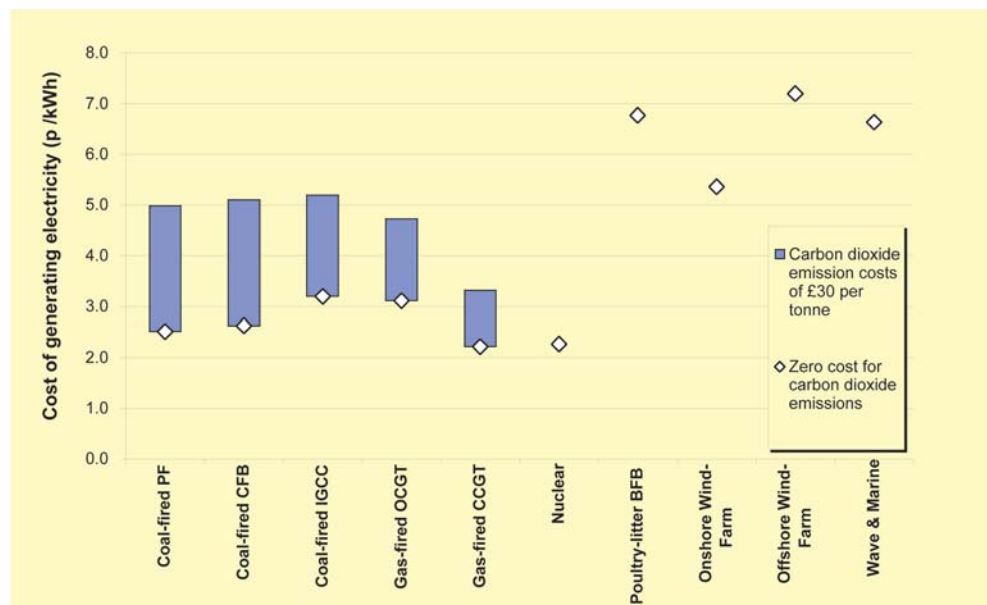

It is clear that CO₂ costs will only affect those technologies burning fossil-fuels. The lower efficiency of steam plant, combined with the greater level of carbon found in coal compared with natural gas, means that the gap between CCGT plant and other coal-fired technologies will widen as the cost of CO₂ increases. The cost of nuclear and other renewables (deemed to be carbon neutral) remain unchanged and, therefore, become more competitive as the specific cost of CO₂ emissions increases.

2. METHODOLOGY

2.1 The problem with electricity...

The fundamental problem with the supply to, and demand for, electricity is that it cannot be stored. Once generated, electricity must be delivered and consumed immediately owing to technical difficulties with, and the prohibitively high cost of, storage. In this regard, electricity is perhaps a unique commodity in that the rate of its production must balance the rate with which it is consumed at all times.

As one might expect, demand for electricity does not remain constant and fluctuations in load occur:

- at different times of the day to reflect the pattern of working hours and the effects of electric lighting, cooking, heating etc;
- on different days of the week to reflect the patterns of industrial and commercial activity on week-days, weekends and holidays; and
- in different months of the year, often reflecting different climatic conditions.

In order to provide a good quality supply of electricity, therefore, sufficient generation plant ('generation capacity') must be constructed to meet demand at its highest point. By implication, this means that there will be times of the day when demand is not at its highest point and generation capacity is standing idle, i.e not all generation capacity is fully utilized all of the time.

This concept of plant utilization is important when analysing the costs of generating electricity. It can be observed that, a plant with low utilization, inevitably has a high unit cost of production because the same investment and fixed costs of operation and maintenance are recovered over fewer units of production. The general relationship between plant utilization and the unit cost of production is illustrated in Figure 2.1 below.

Figure 2.1 – Effect of plant utilization on the unit cost of electricity production

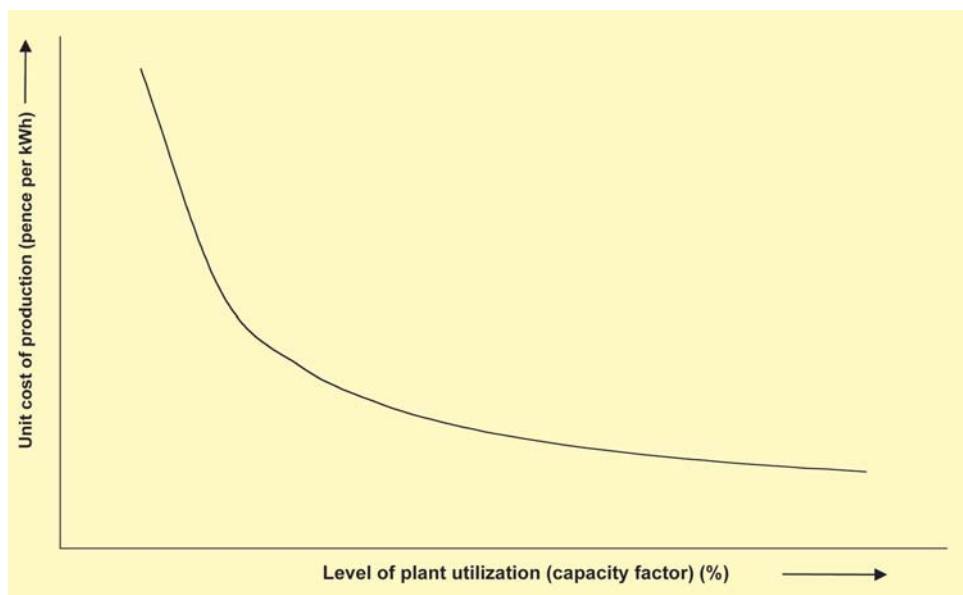

2.2 Relevant costs

The cost of generating electricity, as defined within the scope of this study, is expressed in terms of a unit cost (pence per kWh) delivered at the boundary of the power station site. The relevant costs of generating electricity can, for the purposes of this study, be divided into four main categories:

- **Capital expenditure**, i.e. the initial level of investment required to engineer, procure and construct the plant⁴ itself.
- **Fixed costs of operation and maintenance**, e.g. staff salaries, insurance, rates and other costs, which remain constant irrespective of the actual quantum of electricity generated;
- **Variable costs of operation and maintenance**, e.g. lubricating oil and chemicals, which are consumed in proportion to the actual quantum of electricity generated; and
- The **cost of fuel** (if applicable) consumed in generating electricity.

Thus, with some relatively simple interpolation of the various cost elements, it is possible to express the cost of generating electricity in terms of the unit cost of electricity (pence per kWh) for a given level of plant utilization (or capacity factor).

For the avoidance of doubt, the cost values derived in this study do not include the delivery costs⁵ of transmitting electricity over the transmission and distribution systems to an end-consumer, nor do they include any allowance for the purchase cost of land and relevant permits. With the exception of nuclear, the analysis assumes that the costs of decommissioning are equal to the intrinsic scrap value of the plant equipment itself. In other words, decommissioning is assumed to be cost neutral.

In addition to the direct cost of fuel, we have taken into account the impact of carbon dioxide emissions costs in our analysis. A range of costs has been considered, i.e. from zero to £30 per tonne. For the purposes of illustrating the significance of this cost, a notional value of £10 per tonne was used in the analysis presented in the Annex.

⁴ *A capital project, such as the construction of a generating plant, can be developed in a variety of different ways. In this respect, financing charges, legal fees and developers costs can vary considerably between different projects of a similar type. For simplicity, the capital cost estimates used in this study only refer to the engineering, construction and procurement (EPC) costs of developing a project. The phasing of capital expenditure prior to commercial operation has been modelled to ensure that the cost of interest during construction (IDC) is not overlooked.*

⁵ *Note that transmission and distribution costs increase as the distance of generation from its load increases.*

2.3 Intermittency

In addition to fluctuations in demand, described in Section 2.1, the balance of maintaining a reliable supply of electricity is further complicated by attendant fluctuations in the supply itself.

Fluctuations in supply will occur as a result of:

- fluctuations in the supply of primary energy, such as water for hydro-electric plant, or wind for wind turbine generators;
- the need to take units of generating plant out-of-service periodically for overhaul and routine maintenance, to minimise the risk of unscheduled loss; and
- unscheduled loss (or forced outage) of plant.

Fluctuations in the supply of primary energy, such as coal or gas, should rarely occur with proper operational planning⁶. However, the intermittency of wind, and to a lesser extent water (owing to the fact it can be stored in reservoirs in the case of hydro-electric plants, or predicted in the case of wave and marine technologies), needs special consideration when planning for the needs of a system. One of the challenges faced by this study was to derive a robust approach to compare directly the costs of intermittent generation with more dependable sources of generation on a like-for-like basis.

2.3.1 Extent of wind intermittency

The intermittency of wind raises two main issues with respect to system planning and operation:

- From an operational perspective, sufficient spinning reserve⁷ must be maintained to ensure a stable system given continuous fluctuations in demand and supply. A substantial amount of work has been carried out to investigate whether the intermittency of wind generation, at different levels of penetration, adds to the costs of maintaining adequate spinning reserve. The key assumption generally used in this type of analysis, is to consider the average contribution made by an intermittent source of generation to estimate the most likely out-turn scenario.
- From a planning perspective, sufficient static reserve capacity⁸ must be maintained to ensure that demand can be met when other generating units are taken out of service for maintenance. For planning purposes, it is traditional to take a pessimistic (or worst-case) view of intermittent generation so ensuring that there is a high level of confidence that demand can be met even under extra-ordinary climatic circumstances.

Drawing on sources of published information, it would appear that the majority of studies, undertaken to derive a correlation between generation from wind turbines and system demand, are based on rather limited amounts of time series data (typically 12-months), which, in our view, might not be representative of a worst-case required for planning purposes. We are cognisant of some published studies, however, which suggest that, for small levels of wind (turbine capacity) penetration, the 'equivalent firm' capacity added to the system is equivalent

⁶ *PB Power recognises the concerns of various stakeholders with respect to the security of the UK's supply of natural gas.*

⁷ *Plant that is running at less than 100% output, which can be called on immediately if so required by the system operator.*

⁸ *Plant which is available for use on the system and can be operated given due notice.*

to about 35 per cent of the installed capacity⁹. We have used this figure in the study. Without the benefit of very detailed statistical analysis, it is difficult to draw conclusions relating to the correlation between 'equivalent firm' generation from wind turbines and system demand. For the purposes of this study, therefore, the additional cost of providing standby generation to support the other 65 per cent of intermittent wind turbine capacity, i.e. the amount which is considered 'non-firm', has been analysed.

There are, of course, other system costs associated with fluctuation in supply from all forms of generation. The evaluation of these 'system costs' is considered to be outwith the scope of this study.

2.3.2 Cost of standby generation

In a mature electricity system, with surplus generation capacity like that found in the UK, the cheapest way to provide standby generating capacity will likely be from existing thermal and hydro plants with sunk costs. Given the new entrant cost context of this study, however, we feel that it is more appropriate to employ a proxy for standby generation based on the costs of an open-cycle gas turbine (OCGT): the cheapest new plant option.

The cost of standby generation capacity has been calculated on the basis of the annuitized investment cost and costs of operating and maintaining a suitable OCGT in the UK. For reasons discussed later in Annex A.4, a gas-fired aero-derivative gas turbine in open-cycle configuration was selected to be a suitable proxy for the costs of standby generation. Table 2.1 presents the costs used in the study.

Table 2.1 - Cost of standby generation

Capital cost	(£ per kW)	331
Economic life-expectancy	(years)	20
Discount rate	(%)	7.5
Annuitized cost	(£ per kW p.a.)	32
Fixed costs	(£ per kW p.a.)	10

In addition to the capital cost of providing standby capacity, it should be recognised that there are differences in the cost of electricity generated at peak and off-peak times. For the purposes of this study, we assume that the energy contribution from a wind turbine will, on average, displace fuel which would otherwise be burned in a CCGT plant. In order to account for the full cost of providing standby generation, we have added the difference in marginal cost between the standby generator (OCGT) and the system marginal plant (CCGT) to the proportion of generation which is not considered 'firm' energy. The difference in marginal cost is estimated to be about 1 pence per kWh.

⁹ Value of 35% is provided by David Milborrow in an article, "Renewables – are the fears overegged?", published in Power UK, 2002. The Royal Academy of Engineering estimates a lower value of between 20-25%.

2.4 Selection of technologies

Rather than enumerate all possible fuel and technology combinations, this study focuses on, what we consider to be the preferred combinations of technology and fuel that might be constructed by a commercial developer in the UK today and over the next 15 to 20 years.

Adopting this approach has simplified our evaluation of the different plant options considerably as many of the possible permutations of plant and equipment would involve the rehabilitation of existing plant or retrofitting of new plant and equipment which would, strictly speaking, not be directly comparable technologies appropriate over the time scale of the study.

This study covers the following types of generating plant technology, which are considered to be 'bankable' options for development in the UK and/or likely to be a significant contributor to UK electricity provision in the future:

- pulverised fuel (PF) steam plant;
- circulating fluidized-bed (CFB) combustion plant;
- integrated gasification combined-cycle (IGCC) plant;
- open-cycle gas turbine (OCGT) plant;
- combined-cycle gas turbine (CCGT) plant;
- nuclear fission plant;
- bubbling fluidized-bed (BFB) combustion plant;
- wind turbines (onshore and offshore); and
- marine technologies.

Each of the above technologies is briefly described in the Annex 1 with the results of our cost analysis. It should be noted that both hydroelectric and photovoltaic (PV) technologies have been excluded from our analysis because:

- The scope to construct new hydroelectric plants in the UK is very limited owing to: 1) the majority of viable sites having already been exploited; and 2) construction of dams for the impoundment of large water resources being no longer acceptable for environmental reasons. The principal developments relating to hydroelectric plant in the UK over the coming years will be concerned with rehabilitation of existing facilities. The cost of generating electricity from schemes with sunk costs is specifically excluded from this study.
- PV technology is advancing considerably. It is still, however, relatively expensive compared to other generation technologies. PV has not been included in this study because it is unlikely to be a significant contributor to the UK energy balance within the study horizon owing to: 1) the immaturity of the technology; and 2) the relatively low extent of solar irradiation present in the UK¹⁰.

In addition, it should be noted that energy from waste technologies were not considered as part this study as the electricity produced was deemed to be a by-product from the waste disposal process. It is recognised, however, that the disposal of biomass wastes through incineration, and the subsequent generation of electricity using this source of energy, could make a significant contribution to demand for electric power in the UK in the future.

¹⁰ *Renewables for Power Generation, IEA 2003.*

3. FUELS

3.1 Overview

Fuels used for electricity generation broadly fall into one of three main categories:

- Fossil fuels – commodities such as coal, fuel oil and natural gas which are traded on the international market.
- Biomass fuels – specially grown crops, for example short-rotation coppice, or by-products from other processes, for example, poultry litter.
- Nuclear – uranium or 'MOX' fuel.

The individual characteristics of these fuel types tend to shape the choice and optimum size of the combustion technology employed. By way of example:

Fossil fuel

High specific energy content, therefore cheap to transport from origin.

High environmental cost with respect to emissions, e.g. CO₂ emissions and SO₂ abatement.

Favours large, efficient (typically state-of-the-art) plant technologies with extensive infrastructure to support the delivery of fuel and export of electricity.

Biomass

Low environmental cost and further incentivized with renewable obligation and climate change levy exemption certificates.

Low specific energy content, therefore very expensive to transport from origin. Variable fuel quality. Also seasonal harvesting can mean poor utilization of harvesting and storage facilities.

Favours plants located near to the source of fuel production to avoid high transport costs. Plant size is, therefore, limited by the production capacity of fuel within its vicinity. Wide variability in fuel quality favours simple, robust, plant technology.

From a cost perspective, we can make some broad generalizations about the key drivers which come into play with respect to underlying fuel prices:

- Fossil fuels – prices set in international markets; subject to UK fiscal policy (import duties and taxes); and liable for CO₂ emission related costs.
- Biomass fuels – prices set in local markets; significant transport cost proportional to distance from power station site; high prices offset by Government incentives for renewable generation.
- Nuclear – the cost of nuclear reactor fuel is small compared to the investment cost of the power plant itself. The sensitivity of nuclear plant economics to fuel price is, therefore, low and, as such, is not discussed in any further detail by this study

3.2 Fossil fuel prices

Table 3.1 provides a snapshot of prices for different types of fossil fuels used in generating electricity. These values clearly illustrate that coal is by far the cheapest fuel for generating electricity on an energy supplied basis. What is less clear-cut, however, is the difference between fuel oil and natural gas.

Table 3.1- Snapshot of fuel prices for generation¹¹

			(£ per GJ)
Natural gas	(p /therm)	21.8	2.05
Coal	(£ /tonne) ¹²	40.5	1.39
Heavy fuel oil ¹³	(£ /tonne)	90.0	2.05
Gas oil	(£ /tonne)	155.0	3.29

Unlike coal and natural gas, importers of fuel oil must pay an excise duty of 3.82 pence per litre, equivalent to about £38 per tonne. Using the values stated above, this would make the overall cost of imported heavy fuel oil 42 per cent more expensive than natural gas on an energy supplied basis.

To emphasize this point, Figure 3.1 illustrates the average cost of fuel purchased by major power producers in the UK over the period 1993 to 2002. In this particular data set, fuel oil represents the weighted-average cost of heavy fuel oil and gas oil purchases, which were purchased¹⁴ in the ratio 10:1 for the year 2002.

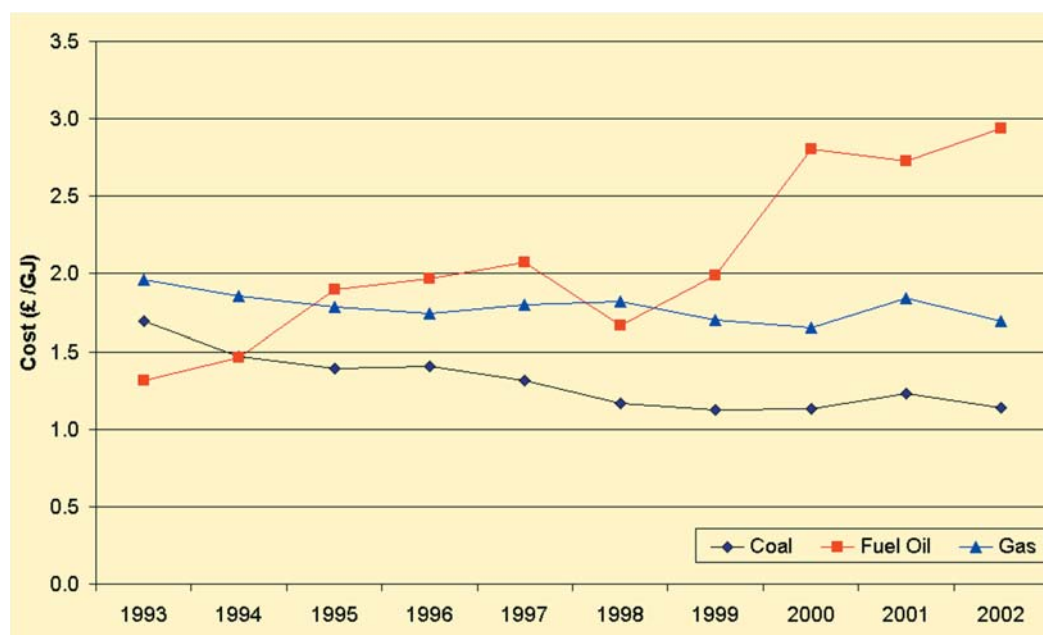
Figure 3.1 – Historical fuel costs for generation¹⁵

¹¹ Month-ahead prices, (net of taxes, duties and delivery charges) for March 2004, values from Platts International Gas Report expressed in Gigajoules HHV.

¹² Values adjusted to correlate with the average calorific value of fuel used by power stations presented in the Digest of UK Energy Statistics 2003, DTI.

¹³ Based on 1% Sulphur Heavy Fuel Oil.

¹⁴ Table 3.4, Digest of UK Energy Statistics 2003, DTI.

¹⁵ Quarterly Energy Prices December 2003, DTI.

Even with these slight distortions due to the averaging of different fuel types and making some allowance for the fuel oil which might be purchased from within the UK, it is clear that under the Government's existing fiscal policy, fuel oil cannot compete with other types of fossil-fuel used to generate electricity. It is our view, therefore, that the scope for future fuel oil-fired generation is very limited, other than for use as a back-up fuel in plants which have the capability to burn more than one type of fuel. This opinion appears to be shared by other stakeholders, for example, in the latest JESS¹⁶ report with its forecast of generation by fuel type. In this regard, heavy fuel oil has been excluded from further consideration in this study.

Although the fuel component of electricity may represent as much as 70 per cent of the total cost of production, deriving a detailed forecast of future fuel prices was outwith the scope of this study. In order to compare the costs of different fuels used in generation, we have calculated the arithmetic average of the cost of coal and gas, as purchased by major power producers over the period 1999 to 2002.

Table 3.2 - Average cost of fossil fuel delivered to major power producers in the UK (1999 to 2002)

		(£ per GJ)	
Natural gas	(p /therm)	18.1	1.72
Coal	(£ /tonne)	30.3	1.16

Although the values given in Table 3.2 fall within the range of price projections published by the DTI¹⁷, it is our view that the price of natural gas relative to coal will increase in the future as UK indigenous resources become depleted and we become more dependent on imported natural gas (including liquefied natural gas (LNG)) from the Continent and elsewhere. The price for natural gas used in this study has, therefore, not been derived from historical average values, but is based on a proxy for the average cost of LNG supplied to EU member countries in 2002, plus an allowance for the costs of LNG regasification.

Table 3.3 - Proxy for future gas price

		(£ per GJ)	
LNG import price	(p /therm)	20 ¹⁸	1.90
Regasification	(p /therm)	3	0.28
		23	2.18

It is interesting to note that the gas price derived above is similar in value to the forward price for natural gas in 2005 published by Heren¹⁹, which at the end of January 2004 was 24 pence per therm.

¹⁶ *Joint Energy Security of Supply Working Group (JESS) Third Report, November 2003.*

¹⁷ *Energy Paper 68 (Energy Projections for the UK), DTI 2000*

¹⁸ *Energy Prices & Statistics, OECD 2003.*

¹⁹ *The Heren Report*

On this basis, it is our view that £30 per tonne for coal and 23 pence per therm for natural gas are representative of the long-term prices for these two commodities and a reasonable benchmark from which to perform sensitivity analyses. We are cognisant, however, that EP68 is currently being revised and is due to be re-issued during March 2004. This report may provide a more detailed analysis of these price projections.

3.3 Biomass fuels

Owing to significant transport costs involved with the majority of different biomass fuels, it is difficult to estimate precisely, given few markets within reach of existing biomass generation plant, the cost of different feedstocks. Some appropriate costs for biomass fuels are given below:

- Poultry litter - £7 per tonne
- Short-rotation coppice (oven-dried) - £40 per tonne
- Wood pellets - £58 - £73 per tonne

To complicate matters, some biomass fuel crops attract various Government subsidies²⁰, which makes it difficult to calculate the real cost of fuel.

For the purposes of this study, we have chosen to use poultry litter in our cost analysis owing to the greater level of operational experience with this fuel in the UK, and the absence of Government subsidies.

²⁰ DEFRA Energy Crop Scheme.

4. ENVIRONMENTAL CONSIDERATIONS

4.1 Legislation

In directive 2001/80/EC, known as the large combustion plant directive (LCPD), the EU sets down limits for the reduction of emissions to air for oxides of nitrogen (NO_x), sulphur dioxide (SO_2) and particulates (dust) from combustion plants with a thermal input greater, or equal to, 50 megawatts (MW_{th}). This replaces the previous directive 88/609/EEC.

The LCPD applies to 'existing', 'new' and 'new-new' plants whereby:

- existing plants are defined as those consented before 1 July 1987 and exempt from 88/609/EEC;
- new plants are defined as those having been built between 1 July 1987 and 31 October 2001, which are obliged to meet the criteria outlined in 88/609/EEC; and
- new-new plants are defined as those commissioned after 31 October 2001 that are obliged to meet the criteria outlined in the LCPD.

The limits applicable to 'new-new' plants are summarised in Table 4.1 and Table 4.2:

Table 4.1 - SO_2 emissions permitted by 'new-new' plants (mg/Nm^3)

Fuel type	50-100 MW_{th}	100-300 MW_{th}	>300 MW_{th}
Biomass fuels	200	200	200
Other solid fuels	850	200	200
Liquid fuels	850	400-200	200

Table 4.2 - NO_x emissions permitted by 'new-new' plants (mg/Nm^3) (measured as NO_2)

Fuel type	50-100 MW_{th}	100-300 MW_{th}	>300 MW_{th}
Solid fuels	400	300	200
Liquid fuels	400	200	200
Natural gas	150	150	100
Other gas	200	200	200

Although the Government has yet to decide whether it will implement the LCPD through a national emissions reduction plan (NERP), emissions trading system (ETS) or emissions limit value (ELV), the instrument of implementation will be via the integrated pollution, prevention and control (IPPC) permitting system. The IPPC permit application will also take into consideration obligations of the national air quality strategy (NAQS) and the pollution prevention and control regulations, 1999, (PPC regs). Therefore, even if the limits set out in the LCPD are achievable by emission abatement technology proposed for a 'new-new' plant, there is no guarantee that the application for a permit to construct and operate would actually be successful.

4.2 Abatement of emissions

In the following subsections, we briefly outline some of the different way in which SO₂, NO_x and particulate emissions can be abated. The preferred abatement technique for each type of generation plant technology is discussed as part of the Annex.

4.2.1 Sulphur dioxide

There are various techniques for reducing emissions of SO₂ during the combustion of fuels used for generating electricity. These techniques are many and varied but include, inter alia:

- use of low sulphur fuels;
- in-furnace sulphur control via the injection of a sorbent, such as calcium oxide or calcium carbonate, during the combustion process;
- flue gas desulphurisation (FGD); and
- fuel gas desulphurisation.

4.2.2 Oxides of nitrogen

Like SO₂, there are various techniques for reducing emissions of NO_x during the combustion of fuels used for generating electricity. For example:

- advanced (dry) combustion systems;
- injection of DeNO_x water;
- low NO_x burners;
- flue gas recirculation;
- reburn;
- selective non-catalytic reduction (SNCR); and
- selective catalytic reduction (SCR).

4.2.3 Particulates

Particulate emissions are generally controlled using one of two main techniques:

- electrostatic precipitators; or
- bag filters.

4.3 Carbon costs

All hydrocarbon fuels release carbon dioxide (CO₂) when they are burned to generate electricity. The specific carbon content of different fuels, however, varies as illustrated in Table 4.3.

Table 4.3 - Carbon content of different fuels²¹

Fuel type	Carbon content	
Coal	(kg /GJ)	22.5
Fuel oil	(kg /GJ)	19.6
Natural gas	(kg /GJ)	14.2

At the time of writing this report, no firm commitment has been given by the Government on how CO₂ emission allowances will be allocated to new entrant generation plant for the period 2005 to 2007 under the forthcoming EU emissions trading scheme. In view of this uncertainty, we have adopted a conservative approach to burden 100 per cent of the output from fossil-fuelled generation with a notional carbon emission cost, calculated in terms of £ per tonne of CO₂ released. For the purposes of this study, a range of values between zero and £30 per tonne was used, where the upper limit reflects the reported cost of CO₂ sequestration.

Although the UK Draft National Allocation Plan, January 2004, does not explicitly state the fact, we have assumed that all renewable sources of generation using straw, poultry litter etc will not be burdened with any carbon emission costs.

²¹ *National Atmospheric Emissions Inventory.*

Annex 1

ANNEX 1 – TECHNOLOGIES

In this Section, we briefly describe the alternative generating technologies considered by the study, and how these technologies may develop over the study period.

The levelized costs presented in this section have been calculated using a discount rate of 7.5 per cent. For illustrative purposes, a notional CO₂ cost of £10 per tonne has been employed in the analysis.

A.1 Coal-fired PF

Conventional pulverized fuel (PF) combustion is a common form of proven generation technology found throughout the world. Finely ground particles of coal are blown into a boiler where they are burned. The heat released is collected through the water walls of the boiler and a series of subsequent heat exchangers, producing high pressure steam. This steam is passed through a steam turbine which in turn drives an electric generator. Although PF plants can be built over a wide range of sizes, for the purposes of this study, PF steam plant is considered suitable for large-scale (greater than 300 MW) schemes where coal is the primary fuel used for generation.

Many different configurations of steam plant are possible, either for cogeneration (combined heat and power) or electricity-only applications. Within the scope of this study, we do not consider cogeneration applications further.

The key design feature of a conventional PF plant is the pressure and temperature at which steam is generated. The majority of plants in the UK (in fact, all that are operational today) operate at subcritical steam conditions. Supercritical boilers, however, are well proven technology which would likely be constructed today owing to their greater level of efficiency. (A new subcritical conventional PF plant can achieve an overall net efficiency of about 38-40 per cent compared to a new supercritical plant that can achieve a net efficiency of about 42 per cent).

Looking towards the future 15 to 20 years, it is likely that more exotic materials will enable the pressure at which steam is generated to increase further. These 'advanced-supercritical' plants will probably achieve yet higher levels of efficiency, perhaps 44 percent, albeit at a slightly higher capital cost over supercritical plants.

Emissions control is an important aspect of all types of PF steam plant. These costs can be minimised, however, if prior consideration is given to the location of power plant and the specification of the fuel burned. For the purposes of this study, we assume that a prospective developer of a PF steam plant will optimise the plant to incorporate the following design features:

- Moderate sulphur coal (blending coals so that the sulphur content is less than 2 per cent by mass) in order to take advantage of the seawater flue gas desulphurisation process, which avoids the additional cost of sorbent such as lime or limestone.
- Low NO_x combustion system, with allowance in the boiler design for selective catalytic reduction (SCR) plant and equipment to be fitted at a later date.
- Use of bag filters to control the emission of particulates.

With these design features, a new PF plant (subcritical, supercritical or advanced supercritical) will meet environmental legislation as set out in the LCPD and be considered as a ‘best available technique’ (BAT).

Table A.1 summarises the main characteristics of coal-fired PF plant that would be constructed today, and one which might be constructed in the future.

Table A.1 - Coal-fired PF plant characteristics

	Current	Future
Notional size of installation (MW)	1,600	
Economic life-expectancy (years)	30	
Construction period (years)	4	
As-new efficiency ²² (%)	38%	40%
Capital cost (£ per kW)	820	860
Annual operation and maintenance (£ per kW)	24	

Figure A.1 summarises the different cost components of generating electricity from present-day coal-fired PF plant.

Figure A.1 – Current cost of generating electricity from coal-fired PF plant.

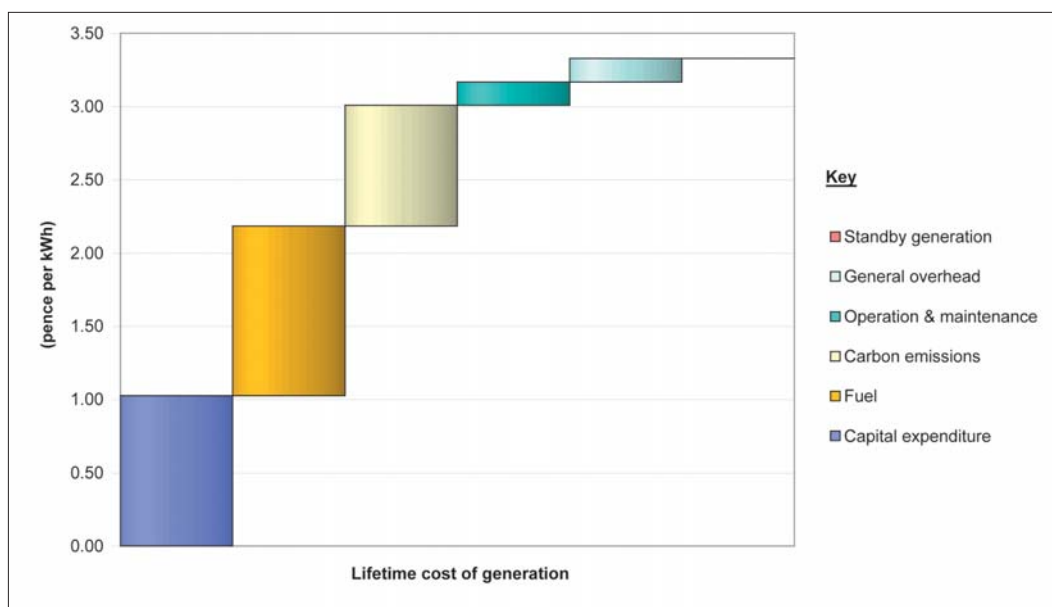

²² As-new efficiency has been adjusted to reflect the parasitic load of FGD plant, which is equivalent to a loss of about 2 percentage points on net efficiency.

Table A.2 summarises the various cost elements, on a per kWh basis, for current coal-fired PF plants and those which might be achievable in the future.

Table A.2 - Current and future costs of coal-fired PF plant generation (pence per kWh)

	Current	Future
Capital expenditure	1.03	1.08
Fuel	1.16	1.10
Carbon emissions	0.82	0.78
Operation & maintenance	0.16	0.16
General overhead	0.16	0.16
Standby generation	0.00	0.00
	3.33	3.28

A.2 Fluidized-bed combustion

Fluidized-bed combustion technologies have some inherent environmental benefits over conventional PF type plants:

- Combustion temperatures are generally lower than those found in typical PF plant. In this regard, lower NO_x emissions are achievable without the need for special combustion systems.
- The need for expensive flue gas desulphurization equipment can be avoided by injecting sorbent (e.g. limestone) directly into the fluidised bed boiler. This has the added benefit of fuel flexibility to burn coals with a wide range of sulphur content.

For the purposes of this study, we consider two types of fluidized bed combustors:

- circulating fluidized-bed combustion (CFB) plant; and
- bubbling fluidized-bed combustion (BFB) plant.

The characteristics of these plants are described in the following subsections. At this stage, however, it is perhaps opportune to mention why pressurised (bubbling or circulating) fluidized-bed combustors (PFBCs) have been excluded from further consideration. Essentially PFBC technology entails passing pressurized hot flue gas through an expander section of a gas turbine before it is then used to raise steam in a conventional boiler. It is our view that a prospective developer would not opt to construct PFBC plant today, or in the near future, because:

- the higher efficiency of PFBC over CFB does not offset the lower availability caused by the lack of opportunity to carry out online repairs; and
- gas turbine materials have advanced such that the optimum design temperature for the expander inlet is greater than can be achieved by proven hot-gas clean-up in the PFBC plant.

A.2.1 Coal-fired CFB

CFB is a well proven technology suitable for medium size (less than 300 MW) coal-fired plants located inland, i.e it does not require the availability of seawater for flue gas desulphurisation. For the purposes of this study, we assume that a prospective developer of a CFB plant would optimise the plant to incorporate the following design features:

- Injection of sorbent into the boiler to control sulphur emissions, with sorbent recirculation from the bag filter to enhance utilization.
- Use of bag filters to control the emission of particulates and enhance sulphur capture.

It is our view that a coal-fired CFB plants constructed today will be of the subcritical type, which has an overall net efficiency of about 38 per cent. In the future, supercritical steam conditions will likely be employed for larger plants resulting in an overall efficiency gain equivalent to about 2 percentage points.

Table A.3 summarises the main characteristics of coal-fired CFB plants that would be constructed today, and those which might be constructed in the future.

Table A.3 - Coal-fired CFB plant characteristics

	Current	Future
Notional size of installation (MW)	150	
Economic life-expectancy (years)	25	
Construction period (years)	4	
As-new efficiency (%)	38%	40%
Capital cost (£ per kW)	730	
Annual operation and maintenance (£ per kW)	38	

Figure A.2 summarises the different cost components of generating electricity from a present-day coal-fired CFB plant.

Figure A.2 – Current cost of generating electricity from coal-fired CFB plant

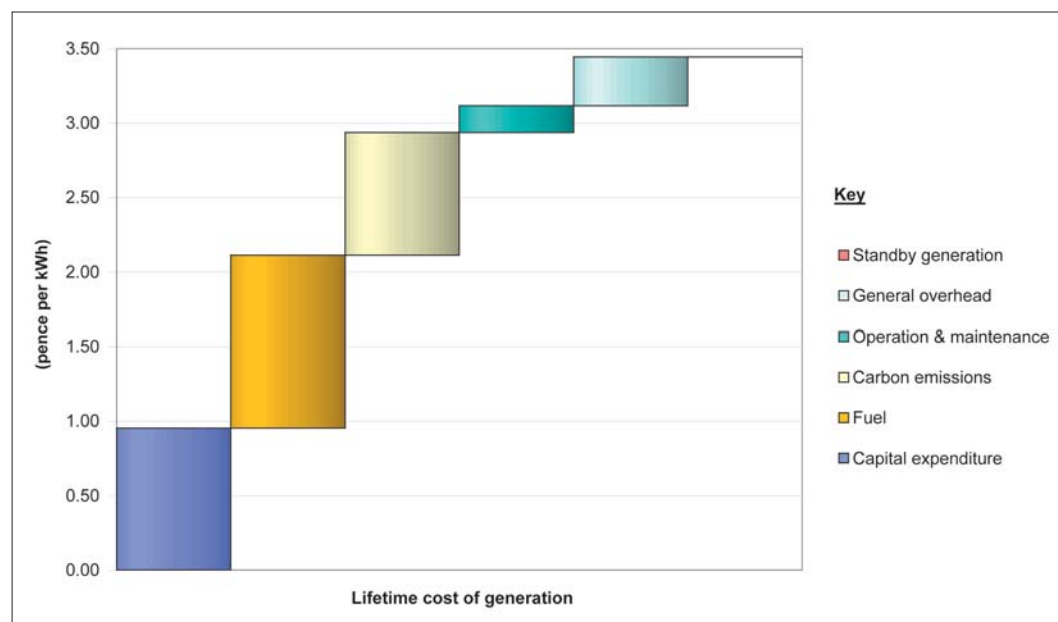

Table A.4 presents the various cost elements, on a per kWh basis, for current coal-fired CFB plants and those which might be achievable in the future.

Table A.4 - Current and future costs of coal-fired CFB plant generation (pence per kWh)

	Current	Future
Capital expenditure	0.95	0.95
Fuel	1.16	1.10
Carbon emissions	0.82	0.78
Operation & maintenance	0.18	0.18
General overhead	0.33	0.33
Standby generation	0.00	0.00
	3.45	3.35

A.2.2 Biomass-fired BFB

BFB is a well proven technology suitable for small (less than 100 MW) biomass-fired plants located in the UK. The bubbling fluidised bed provides thermal inertia which makes it suitable for combustion of fuels of high and variable moisture content and fuels which are difficult to pulverise effectively (such as woody materials). It also has the benefits described for the CFB.

Table A.5 summarises the main characteristics of biomass-fired BFB plant that would be constructed today. It is our view that there is limited opportunity to make significant efficiency gains or reduce costs in the future with this proven technology. Most of the challenges facing this technology relate to its development to burn different types of fuel.

Table A.5 - Biomass-fired BFB plant characteristics

	Current	Future
Notional size of installation (MW)	10	
Economic life-expectancy (years)	20	
Construction period (years)	2	
As-new efficiency (%)	24%	
Capital cost (£ per kW)	1,840	
Annual operation and maintenance (£ per kW)	225	

Figure A.3 summarises the different cost components of generating electricity from present-day technology biomass-fired BFB plant.

Figure A.3 – Current cost of generating electricity from biomass-fired BFB plant

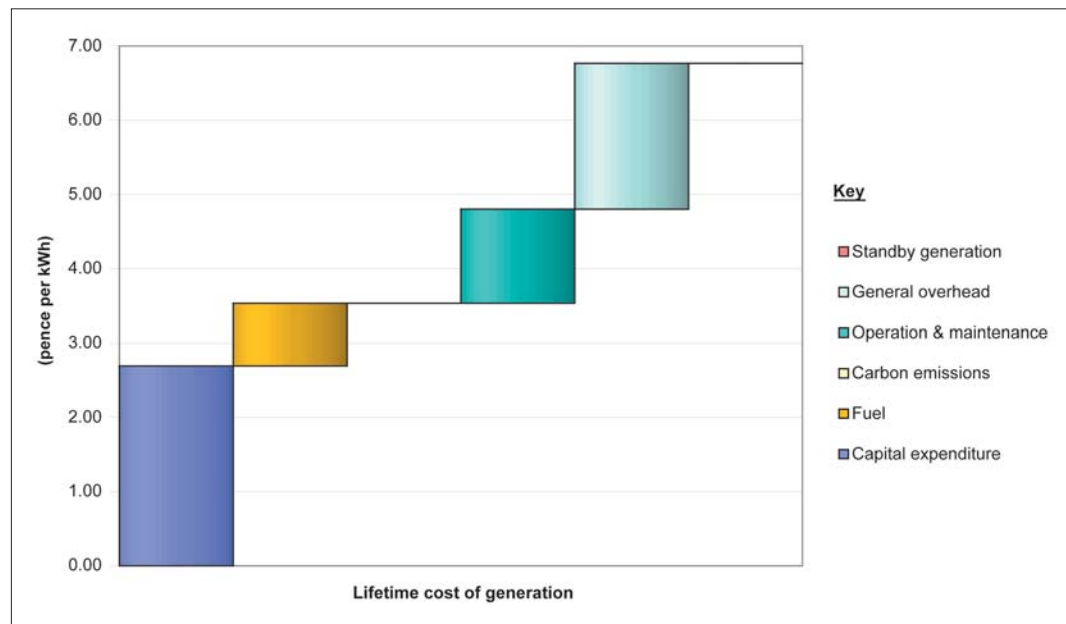

Table A.6 presents the various cost elements, on a per kWh basis, for current technology biomass-fired BFB plant.

Table A.6 - Current and future costs of biomass-fired BFB plant generation (pence per kWh)

	Current
Capital expenditure	2.69
Fuel	0.84
Carbon emissions	0.00
Operation & maintenance	1.27
General overhead	1.96
Standby generation	0.00
	6.76

A.3 Coal-fired IGCC

Integrated gasification plants offer environmental benefits but at greatly increased capital cost when compared to more conventional combustion technology. The operational experience of these plants is also relatively limited.

There are a number of different gasification technologies available which have been proven on large scale plants. The type considered within this report would involve an oxygen blown gasifier into which a coal/water slurry is sprayed at high pressure. The partial combustion which occurs would yield a synthetic gas (syngas) which is predominantly carbon monoxide and hydrogen. This syngas would be cleaned prior to it being combusted within a high efficiency gas turbine combined cycle power plant. Sulphur would be removed from the syngas producing elemental sulphur which could either be stored or used in the chemical industry.

Coal gasification offers the following benefits:-

- Cleaning of the syngas can result in very low stack emissions, comparable with natural gas firing.
- High combined cycle efficiencies can be obtained of the order of 48 per cent by utilising the most advanced gas turbine technologies available.
- Can be designed to handle fuels with very high sulphur content.
- Produces a sintered glassy ash which locks-in most chemical components present in the fuel ash.
- Offers the potential to remove carbon dioxide from the syngas for carbon dioxide sequestration, producing essentially a hydrogen syngas.

Appropriate treatment of the by-product streams from the gasification process and ensuring a safe design, means that the capital cost of such plants is high. It is envisaged that IGCC plants would comprise sites with a power generation in excess of 400 MW, with multiple oxygen separation plants and gasifier modules so as to achieve a high overall availability of the power generation plant.

Table A.7 summarises the main characteristics of coal-fired IGCC plant that would be constructed today. In the future, additional efficiency gains in IGCC technology may be achievable by improvements to oxygen separation, fuel cell technology and advances in gas turbine technology. Within the study horizon, however, it is our view that only modest efficiency improvements of 2 per cent, say, will be commercially available²³ by 2020.

Table A.7 - Coal-fired IGCC plant characteristics

	Current	Future
Notional size of installation (MW)	480	
Economic life-expectancy (years)	25	
Construction period (years)	5	
As-new efficiency (%)	48%	50%
Capital cost (£ per kW)	1,000	
Annual operation and maintenance (£ per kW)	48	

Figure A.4 summarises the different cost components of generating electricity from present-day technology coal-fired IGCC plant.

Figure A.4 – Current cost of generating electricity from coal-fired IGCC plant

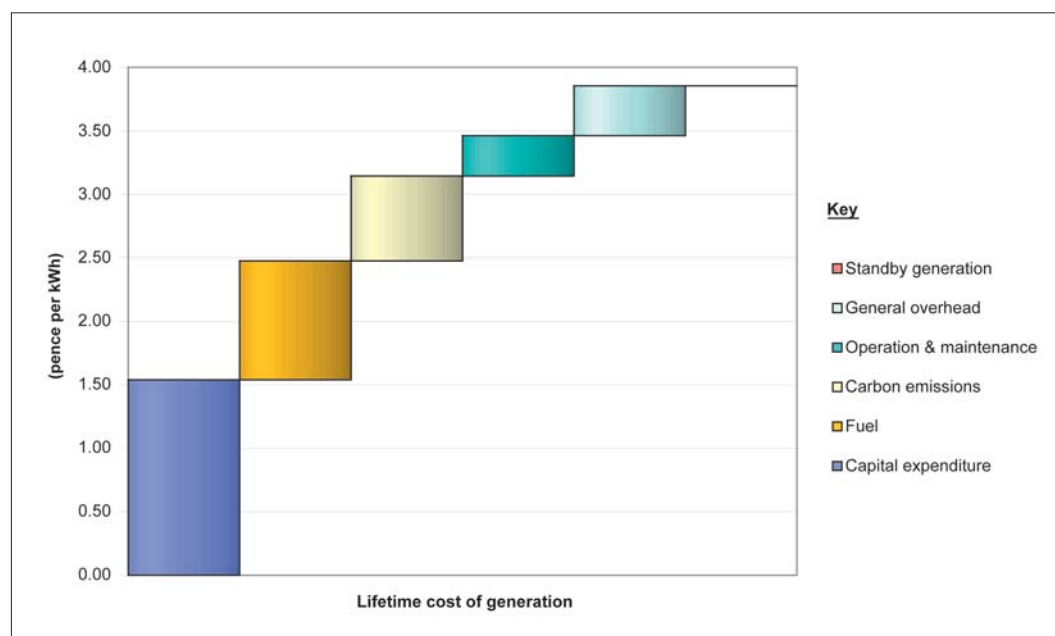

²³ It should be noted that the USA have a programme called VISION 21 which hopes to develop an IGCC based power plant with an HHV efficiency of 50-60 per cent. However, at that stage it may only be a demonstration plant.

Table A.8 presents the various cost elements, on a per kWh basis, for current technology coal-fired IGCC plant.

Table A.8 - Current and future costs of coal-fired IGCC plant generation (pence per kWh)

	Current	Future
Capital expenditure	1.54	1.54
Fuel	0.94	0.90
Carbon emissions	0.67	0.64
Operation & maintenance	0.32	0.32
General overhead	0.39	0.39
Standby generation	0.00	0.00
	3.86	3.79

A.4 Gas turbines

Gas turbines can be divided into three main types:

- Heavy-duty industrial gas turbines (GTs), which are considered 'conventional in design': The firing temperatures and cycle efficiency of these units are conservative by modern standards and this is reflected in the design and choice of materials throughout the GT. These units range in output from 15 to 170 MW and yield an open cycle efficiency of approximately 29 to 34 per cent. These conventional design units are noted for being very reliable machines and they have accumulated considerable operating hours.
- Heavy-duty industrial GTs, which are considered 'state of the art': The firing temperatures, compression ratios, combustion systems, cooling and sealing systems, material selection, manufacturing processes and blading designs in these machines are considered in many cases to be 'state of the art'. In general, these units fall into two main output bands in simple cycle 50 Hz configuration: 60 to 70 MW and 250 to 270 MW. The open cycle efficiency figures range from about 34 to 38 per cent.
- Aero-derivative GTs: These GTs, as the term suggests, are land-based derivatives of successful aero-engine designs. Aero-derivative units are characterised by high open cycle efficiency figures and short start-up times, compared with heavy-duty industrial GTs. The largest aero-derivative GTs are in the region of 45 to 50 MW, going down to 2 to 3 MW at the low end of the range. Typically, open cycle efficiencies in the 25 to 50 MW output band are in the range 38 to 42 per cent.

All three types of gas turbines can be used in open-cycle (OCGT) or combined-cycle (CCGT) configuration, which are described below in more detail.

A.4.1 Gas-fired OCGT

In an OCGT power plant the main components comprise the GT, generator and the associated auxiliary systems such as the fuel supply system, lube oil cooling system, fire protection system and the control system.

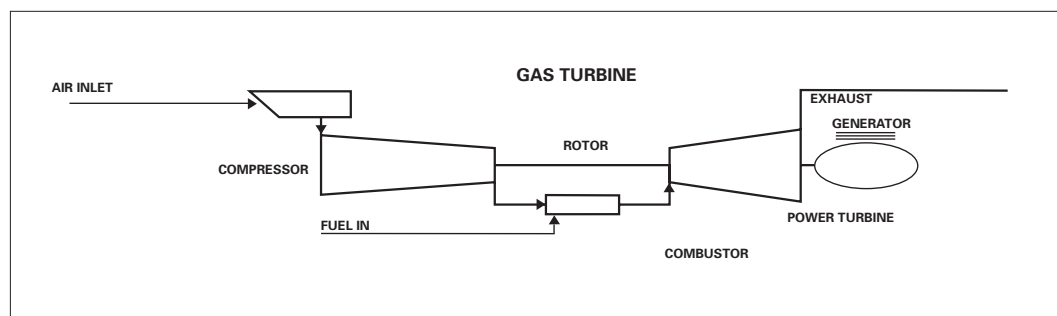
Figure A.5 – Typical OCGT configuration

For the purposes of this study, it is our view that an aero-derivative based OCGT is the most appropriate for the UK market owing to the relatively high cost of natural gas and need for highly flexible plant.

Table A.9 summarises the main characteristics of a gas-fired OCGT plant that would be constructed today, and one which might be constructed in the future.

Table A.9 - Gas-fired OCGT plant characteristics

	Current	Future
Notional size of installation (MW)	40	
Economic life-expectancy (years)	20	
Construction period (years)	1	
As-new efficiency (%)	39%	43%
Capital cost (£ per kW)	330	
Annual operation and maintenance (£ per kW)	34	

Figure A.6 summarises the different cost components of generating electricity from a typical gas-fired OCGT plant constructed today.

Figure A.6 – Current cost of generating electricity from gas-fired OCGT plant

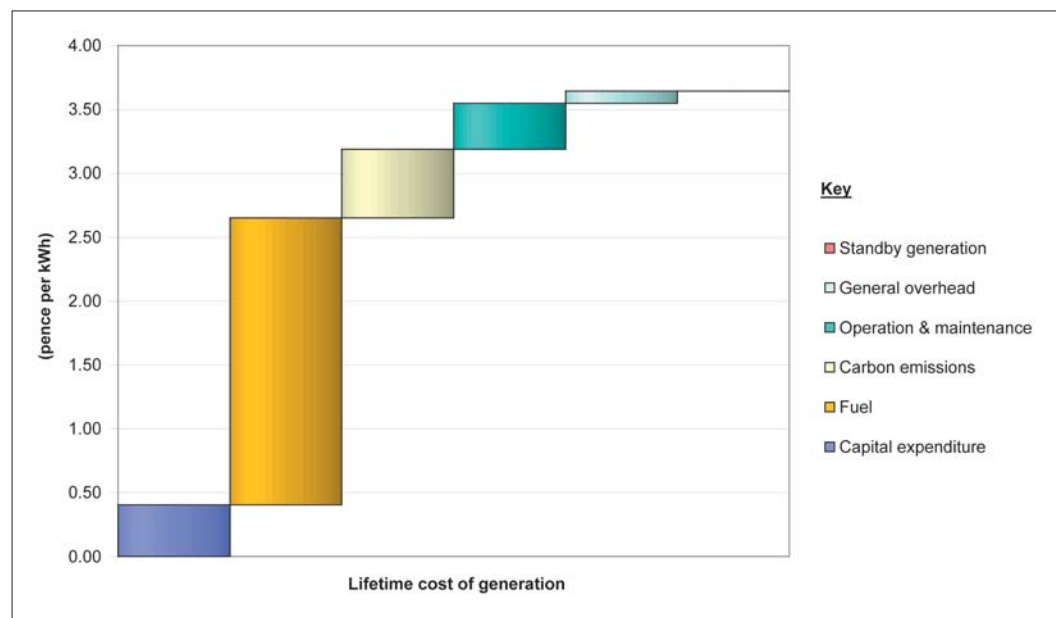

Table A.10 presents the various cost elements, on a per kWh basis, for a current technology gas-fired OCGT plant.

Table A.10 - Current and future costs of gas-fired OCGT plant generation (pence per kWh)

	Current	Future
Capital expenditure	0.40	0.40
Fuel	2.25	2.06
Carbon emissions	0.54	0.49
Operation & maintenance	0.36	0.36
General overhead	0.10	0.10
Standby generation	0.00	0.00
	3.64	3.41

A.4.2 Gas-fired CCGT

In a CCGT power plant, the hot exhaust gases from the GT are delivered to a heat recovery steam generator (HRSG). The HRSG is a heat exchanger in which heat energy in the gases exhausted from the GT is transferred to water, which is then converted to steam. The medium-pressure high temperature steam generated in the HRSG is then delivered to a steam turbine (ST). In a CCGT plant, about two-thirds of the electrical power is derived from the GT and one-third from the ST.

The quality of the flue gas emitted from a GT in combined cycle mode is the same as from a GT in open cycle mode. However, the quantity of emissions for a notional level of output (CO₂ per kWh) is greatly reduced owing to the improved efficiency of CCGT plant.

Figure A.7 – Typical CCGT configuration

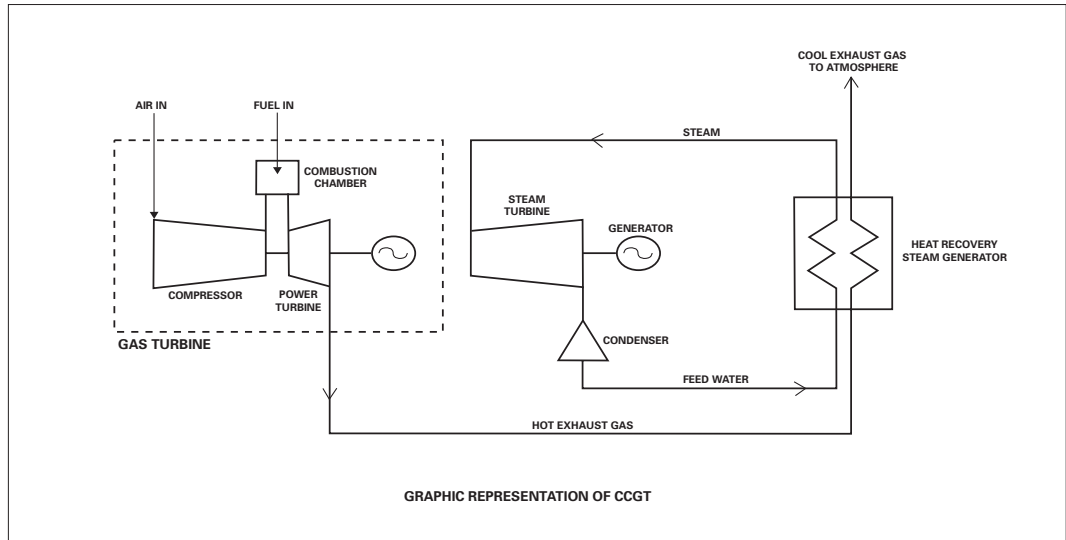

For the purposes of this study, it is our view that a state-of-the-art heavy duty gas turbine based CCGT is the most appropriate for the UK market owing to the relatively high cost of natural gas and high level of competition between generators.

Table A.11 summarises the main characteristics of gas-fired CCGT plant that would be constructed today, and one which might be constructed in the future.

Table A.11 - Gas-fired CCGT plant characteristics

	Current	Future
Notional size of installation (MW)	786	
Economic life-expectancy (years)	25	
Construction period (years)	2	
As-new efficiency (%)	58%	60%
Capital cost (£ per kW)	300	
Annual operation and maintenance (£ per kW)	25	

Figure A.8 summarises the different cost components of generating electricity from present-day technology gas-fired CCGT plant.

Figure A.8 – Current cost of generating electricity from gas-fired CCGT plant

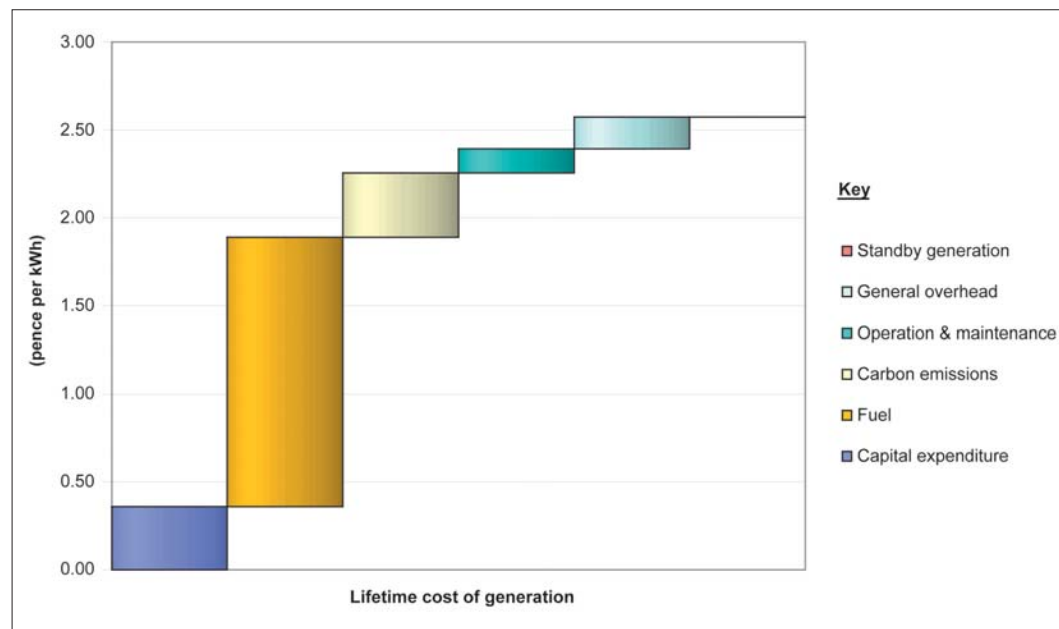

Table A.12 presents the various cost elements, on a per kWh basis, for current technology gas-fired CCGT plant.

Table A.12 - Current and future costs of gas-fired CCGT plant generation (pence per kWh)

	Current	Future
Capital expenditure	0.36	0.36
Fuel	1.53	1.47
Carbon emissions	0.37	0.35
Operation & maintenance	0.14	0.14
General overhead	0.18	0.18
Standby generation	0.00	0.00
	2.57	2.50

A.5 Nuclear fission

Nuclear power plants currently account for more than 20 per cent of total UK electricity demand, with the majority coming from advanced gas cooled reactors (AGRs). The last of these were commissioned in the late 1980s and can be expected to be decommissioned in stages over the next few decades. The predecessors to the AGRs, the Magnox reactors, account for a reasonable share of nuclear generation, but these are already being decommissioned and are expected to be phased out by 2010. The only other nuclear plant built since the AGRs is the Sizewell B pressurised water reactor (PWR) which began operation in 1996.

The nuclear industry is proposing advances on existing designs with increased safety, some standardisation to facilitate licensing, reduced costs, and greater efficiencies. It is likely that any new build in the UK would take advantage of these improvements. TVO²⁴ has selected a European Pressurised Reactor (EPR) for the Finnish project. This has been developed by and contracted to Framatome, a joint venture company between Areva of France and Siemens of Germany. Other realistic options for the short-term include the AP1000 reactor being developed by Westinghouse which is owned by BNFL, and the Advanced CANDU Reactor (ACR), a development of the Canadian Deuterium-Uranium reactor. These three options have yet to be built, and have yet to be licensed in the UK. Even more promising technologies are being researched, such as the Pebble Bed Modular Reactor (PBMR), a high temperature reactor (HTR) benefiting from inherent safety features and small size, though these are only likely to be commercialised in the longer term.

Apart from public concern over nuclear power generation, the attractiveness of CCGT generation has also precluded new build of nuclear plant. In competitive markets, the high capital costs and long construction times of nuclear plant have made it uncompetitive. The nuclear industry has stated that costs have fallen significantly but this has been difficult to validate from the limited number of recent projects.

A recent study²⁵ carried out by the Massachusetts Institute of Technology (MIT) in 2003 reviewed different sources of cost estimates for new nuclear generation including the following:

- Energy Information Administration (EIA), Annual Energy Outlook, 2003
- US Department of Energy (DOE) Office of Nuclear Energy (NE), Roadmap Study, 2001
- Nuclear Energy Agency (NEA) / International Energy Agency (IEA) Projected Costs of Generating Electricity, Update 1998
- UK Performance and Innovation Unit (PIU), Nuclear Power in the OECD, 2001
- Feasibility study for the Finnish Olkiluoto 3 project
- Reported costs of recent projects in Asia.

²⁴ *Olkiluoto 3 unit is currently being developed by TVO in Finland for operation in 2009. TVO operates as a not-for-profit company to provide electricity to its shareholders, a consortium of large industrial energy users. Under this arrangement, the scheme faces significant benefits including no income tax, corporate financing, and most significantly a long-term power purchase agreement (PPA) for its output.*

²⁵ *"The Future of Nuclear Power – An Interdisciplinary Study", Massachusetts Institute of Technology, 2003*

The capital cost of a new nuclear plant represents the majority of the total cost of generation, typically as much as 70% for a base load plant. The MIT report proposed a total cost, stated in nominal terms, excluding interest during construction (IDC) but including decommissioning, of about £1150 per kW for the base case. The capital cost seems a reasonable²⁶ mid-point for the sources reviewed by MIT and for the additional sources we have identified. However, the range of prices proposed indicate the uncertainty there is in the market place over the costs of new-build nuclear power plants. Reasonably we would extend our level of uncertainty to be ± 25 per cent.

Base case O&M costs of about 0.94 pence per kWh, has been proposed by MIT. MIT recognises that this is lower than the average cost of historical data it has reviewed but suggests that efficiency gains can be achieved. Other reports reviewed by MIT, as well as other reports reviewed by ourselves suggest that O&M costs are half this amount. On balance, we have proposed O&M costs of new nuclear plant of about 0.5 pence per kWh.

Fuel costs for nuclear plant are less contentious. MIT proposes a range of 0.3 to 0.4 pence per kWh. This is slightly lower than data sources we have reviewed and therefore we have proposed a fuel cost of about 0.4 pence per kWh. We note that there is a separate debate in the industry about the sustainability of uranium supply and resultant prices, but the fuel cost component of the total cost of generation is relatively small.

Due to the relatively low variable costs, and the difficulty of two-shifting, new-build nuclear generation would only be considered for base-load operation. Availabilities exceeding 90 per cent should be achievable.

Table A.13 summarises the main characteristics of a typical nuclear fission plant examined by the study. As a sensitivity to the main analysis, we provide estimates of the cost of generating electricity from nuclear fission assuming a shorter economic life of 25 years compared with 40 years.

Table A.13 - Nuclear fission plant characteristics

	Current	Sensitivity
Notional size of installation (MW)	1,000	
Economic life-expectancy (years)	40	25
Construction period (years)	5	
As-new efficiency (%)	n/a	
Capital cost ²⁷ (£ per kW)	1,150	
Annual operation and maintenance (£ per kW)	41	

²⁶ TVO is reported to have signed a €3 billion contract with Areva and Siemens for a 1600 MW European Pressurised water Reactor (EPR) in December 2003. The cost of this contract is equivalent to about £1250 per kW. It is our view that, owing to it being the first contract of this type, there are cost savings to be made in the future with regard to the construction of multiple units of the same design and joint certification / licensing. Based on these assumptions, we believe that the cost estimate proposed by MIT (£1150 per kW) is reasonable for the purposes of this study.

²⁷ The capital cost estimate for nuclear plant includes an allowance for the costs of decommissioning.

Figure A.9 summarises the different cost components of generating electricity from nuclear fission plant.

Figure A.9 - Current cost of generating electricity from nuclear fission plant

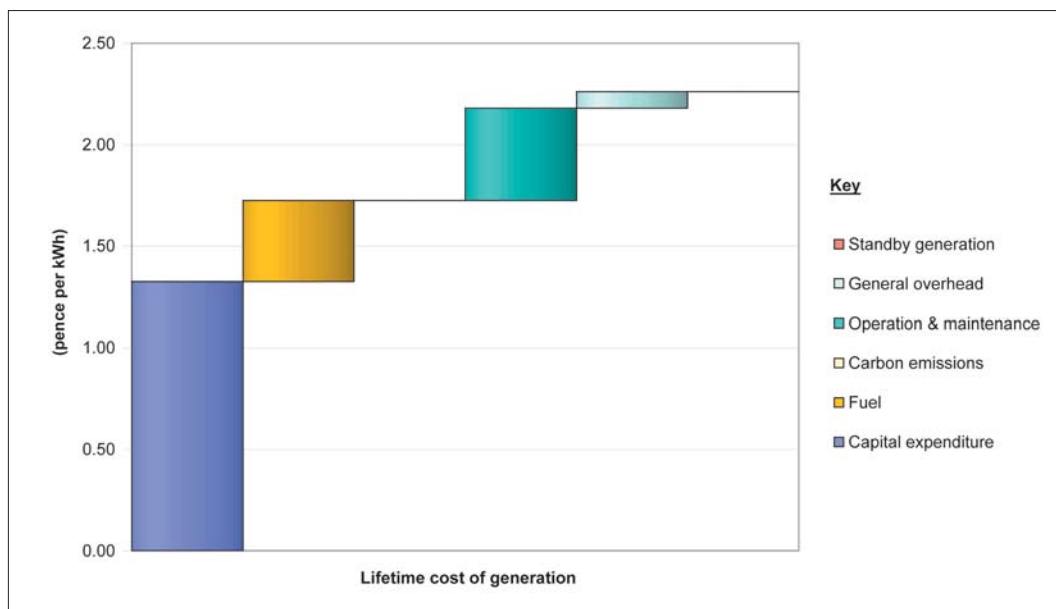

Table A.14 presents the various cost elements, on a per kWh basis, for nuclear fission plant.

Table A.14 - Current costs of nuclear fission plant plus 25 year life sensitivity analysis (pence per kWh)

	Current	Sensitivity
Capital expenditure	1.32	1.50
Fuel	0.40	0.40
Carbon emissions	0.00	0.00
Operation & maintenance	0.45	0.46
General overhead	0.08	0.08
Standby generation	0.00	0.00
	2.26	2.44

A.6 Wind turbines

Until the mid 1980's, wind turbines had a typical output of less than 100 kW. In the mid 1990's they ranged from 0.5 MW – 1.5 MW, located onshore and usually grid connected. Today, commercial prototypes of 3.6 MW wind turbines are being installed.

The trend towards larger turbines with larger rotor diameters continues, and with these advancements will come greater reductions in cost. In addition, economies of scale will be achieved as the size of wind farm projects increases. This is particularly valid for offshore wind farms, where there are now plans for wind farms in the order of hundreds of MW, rather than just tens of MW as previously developed onshore.

It is difficult to say, with any certainty, how the aforementioned trends will affect the overall cost of wind turbine technology. For the purposes of this report, therefore, we assume that a notional reduction of 15 per cent is achievable within the study horizon.

A.6.1 Onshore

Table A.15 summarises the main characteristics of onshore wind turbines today, and in the future.

Table A.15 - Onshore wind farm characteristics

	Current	Future
Nameplate capacity (MW)	24 ²⁸	
Net power output ²⁹ (MW)	21	
Capacity factor	35%	
Economic life-expectancy (years)	20	
Construction period (years)	2	
As-new efficiency (%)	n/a	
Capital cost (£ per kW)	740	630
Annual operation and maintenance (£ per kW)	24	

²⁸ Based on twelve 2 MW wind turbine generators.

²⁹ The net power output value takes account of the effects of grouping wind turbines in an array and the losses incurred in transmitting the power from individual turbines to one central point.

Figure A.10 summarises the different cost components of generating electricity from present-day technology onshore wind turbines.

Figure A.10 – Current cost of generating electricity from an onshore wind farm



Table A.16 presents the various cost elements, on a per kWh basis, for current onshore wind turbine plant.

Table A.16 - Current and future costs of onshore wind farm generation (pence per kWh)

	Current	Future
Capital expenditure	2.78	2.36
Fuel	0.00	0.00
Carbon emissions	0.00	0.00
Operation & maintenance	0.49	0.42
General overhead	0.41	0.41
Standby generation	1.67	1.58
	5.35	4.78

A.6.2 Offshore

Table A.15 summarises the main characteristics of offshore wind turbines today, and in the future.

Table A.17 - Offshore wind farm characteristics

	Current	Future
Nameplate capacity (MW)	94 ³⁰	
Net power output ³¹ (MW)	84	
Capacity factor	35%	
Economic life-expectancy (years)	20	
Construction period (years)	2	
As-new efficiency (%)	n/a	
Capital cost (£ per kW)	920	780
Annual operation and maintenance (£ per kW)	57	

Figure A.11 summarises the different cost components of generating electricity from present-day technology offshore wind turbines.

Figure A.11 – Current cost of generating electricity from offshore wind farms

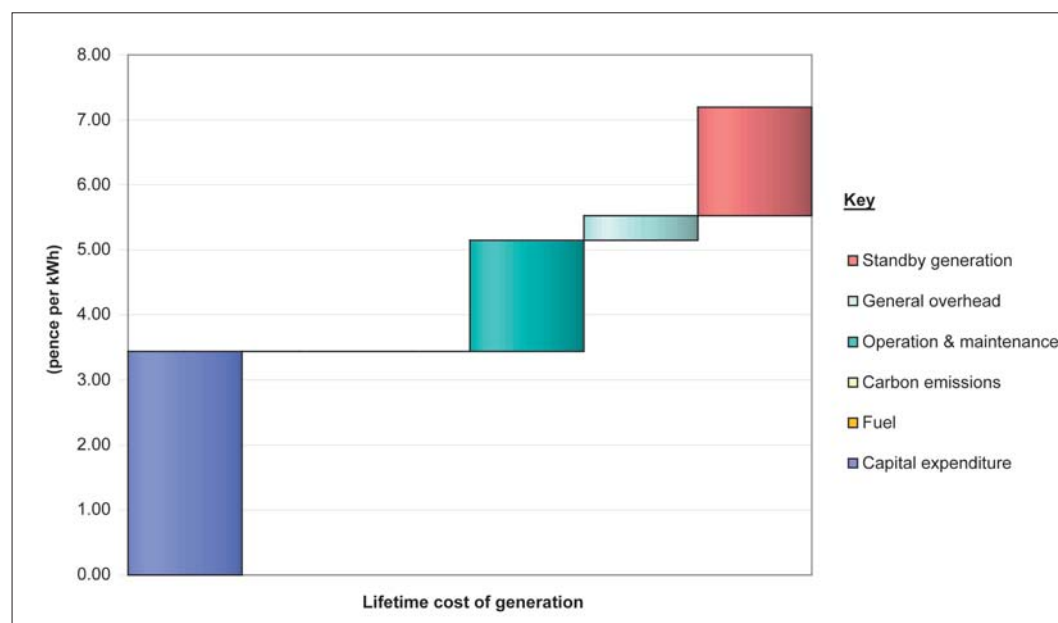

³⁰ Based on twenty-six 3.6 MW wind turbine generators.

³¹ The net power output value takes account of the effects of grouping wind turbines in an array and the losses incurred in transmitting the power from individual turbines to one central point.

Table A.16 presents the various cost elements, on a per kWh basis, for current offshore wind turbine plant.

Table A.18 - Current and future costs of offshore wind farm generation (pence per kWh)

	Current	Future
Capital expenditure	3.44	2.92
Fuel	0.00	0.00
Carbon emissions	0.00	0.00
Operation & maintenance	1.70	1.45
General overhead	0.38	0.38
Standby generation	1.67	1.58
	7.19	6.34

A.7 Wave and Marine technologies

Wave and marine broadly encompasses five different types of technology considered to be relevant to the UK.

- Tidal barrages - construction of a barrage, through which seawater flows to provide power to turbine generators. Tidal barrages, whilst a commercially proven technology, are not considered as viable in the medium-term until environmental concerns can be appeased.
- Offshore tidal current turbine - which generates electricity by using the energy in the currents created by tidal streams. Marine Current Turbines (MCT) has developed the first prototype, the "Seaflow Project", which underwent trials during 2003 off the coast of Devon. MCT plan a pre-commercial installation in 2004/05 of 3 to 4 extra units to give a combine power output of about 4 – 5 MW. The design is currently limited to water depths of between 20 to 40 m, although it is possible that suitable technology may become available in the next 10 years which will allow the exploitation of deeper fast-moving currents.
- Oscillating hydroplane – which generates electricity by using the energy in the currents created by tidal streams. The Engineering Business (EB) is currently developing a machine known as the "Stingray", which works on the principal of an oscillating hydroplane. Stingray underwent offshore testing in the Shetland Islands during summer 2003 and plans to construct a "pre-commercial" (funded by EB) demonstration installation of 5 - 10 one MW units in 2005/2006. Water depth is not critical to the siting of the generator and location is dependent upon the clearance required above it (for shipping etc). Speed of the tidal stream is the determining factor.
- "Pelamis" sea snake. When floating on the sea, hinged joints between its semi-submerged articulated cylindrical sections move with the waves, powering hydraulic motors which then generate electricity. The prototype "Pelamis" has been developed by Edinburgh-based Ocean Power Delivery, and is 120 metres long, 3.5 metres wide and 700 tonnes in weight. Several devices can be connected and linked to shore through a seabed cable, with a 30MW wave farm occupying one square km of sea. The 750 kW prototype is to be tested at the European Marine Energy Centre in Orkney during 2004.

- Oscillating Water Column Device (OWC). The OWC device comprises a partly submerged concrete or steel structure, open below the water surface, inside which air is trapped above the water free surface. The oscillation of the internal free surface produced by the incident waves makes the air to flow through a Wells turbine that drives an electric generator. The only generating wave power station in the UK is the 500kW "Limpet", operated by Wavegen and located on the Scottish Island of Islay. It was commissioned in 2000, and operates under an SRO-3 contract.

Although a significant amount of research and development into wave and marine technologies is being undertaken, it is difficult to estimate the present-day and future costs of this technology.

Table A.19 summarises the main characteristics of wave and marine technologies assumed in this study for today, and in the future assuming a cost reduction of 15 per cent is achievable within the study horizon.

Table A.19 - Wave and marine technology characteristics

	Current	Future
Notional size of installation (MW)	12	
Economic life-expectancy (years)	15	
Construction period (years)	2	
As-new efficiency (%)	n/a	
Capital cost (£ per kW) ³²	1400	1190
Annual operation and maintenance (£ per kW)	56	

³² "Renewable Supply Chain Gap Analysis", DTI, 2004 "Renewable Supply Chain Gap Analysis", DTI, 2004

Figure A.12 summarises the different cost components of generating electricity from present-day wave and marine technologies.

Figure A.12 Current cost of generating electricity from wave and marine technologies

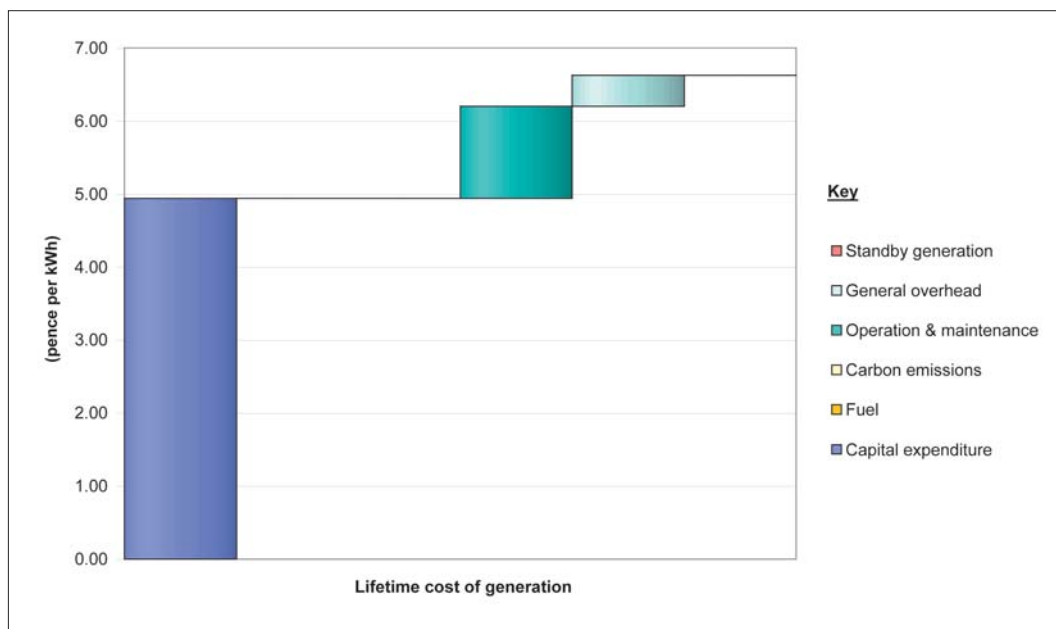

Table A.20 presents the various cost elements, on a per kWh basis, for current wave and marine technologies.

Table A.20 - Current and future costs of wave and marine generation (pence per kWh)

	Current	Future
Capital expenditure	4.94	4.20
Fuel	0.00	0.00
Carbon emissions	0.00	0.00
Operation & maintenance	1.26	1.07
General overhead	0.43	0.43
Standby generation ³³	0.00	0.00
	6.63	5.70

³³ The additional cost of standby generation for wave and marine technologies has not been included because only low levels of penetration are expected within the study horizon.

Annex 2

ANNEX 2 - THE ROYAL ACADEMY OF ENGINEERING ENERGY PORTFOLIO

The Royal Academy of Engineering has been involved in developing its own position and influencing policy for a number of years. As a multidisciplinary field of engineering, this is an area where The Academy can best use the diversity of backgrounds of its Fellows. Both proactive studies and responses to consultations have been carried out by The Academy's Energy Working Group.

NUCLEAR ENERGY: THE FUTURE CLIMATE, JUNE 1999

The Royal Society and The Royal Academy of Engineering set up a joint working group to examine one aspect of energy policy where there is a powerful temptation to procrastinate: the role of nuclear energy in generating electricity. This had been given extra prominence by the Kyoto commitments on emissions of greenhouse gases in general and carbon dioxide in particular. The academies' aim was to survey the full range of current and potential technologies for generating electricity and, against that background, to form a view on the future role for nuclear.

http://www.raeng.org.uk/news/publications/reports/pdfs/Nuclear_Energy.pdf

THE ROLE OF THE RENEWABLES DIRECTIVE IN MEETING KYOTO TARGETS, OCTOBER 2000

A joint Royal Academy of Engineering and Royal Society response to the European Commission on establishment of targets for the generation of electricity from renewable sources following the Kyoto Protocol. This response aired concerns over security of supply issues, potential build rate and questioned the appropriateness of the financial instruments proposed to ensure that the electricity market met the targets. It recommended a "Carbon Tax" on all primary fuels rather than financial instruments which were not directly linked to emissions.

http://www.raeng.org.uk/news/publications/reports/pdfs/Renewables_Directive.pdf

FUELLING THE FUTURE, FEBRUARY 2001

The Energy Futures Task Force published a consultation document entitled "Fuelling the Future" in December 2000. The document set out four scenarios for future energy use in the UK and attempted to draw out R&D priorities for each. The Academy's response expressed concern at the shortfall occurring in the numbers of newly qualified entrants to the disciplines of importance to the energy and environment sector. Overall, this situation was due to the general malaise in the perception of engineering and science by young people. This was a huge problem that might eventually be addressed by market forces, i.e. engineers being in such demand that salaries rose significantly, or through the continued work by many organisations to promote engineering as a career option. Proper application of the 'polluter pays' principle to the energy market was suggested as a mechanism for highlighting the importance of the energy sector to the general public.

http://www.raeng.org.uk/news/publications/submissions/pdfs/Fuelling_the_Future.pdf

PIU ENERGY REVIEW SCOPING NOTE, SEPTEMBER 2001

This Academy response to the Performance and Innovation Unit applauded the decision to formulate properly an energy policy for the UK. For too long there had been no policy other than that of "market forces", with various initiatives started and progressing in a vacuum. To take a long term outlook, to 2050, was encouraging but it also stressed that it was important that the outcome was "holistic" so that the various government bodies subsequently adopted the policy and used specific aspects to direct activities in areas under their control, thereby avoiding a break down in the "joined-up" approach.

http://www.raeng.org.uk/news/publications/submissions/pdfs/Energy_Policy_Review.pdf

ENERGY POLICY – SECURITY OF SUPPLY, OCTOBER 2001

The Academy's response to the House of Commons Select Committee for Trade and Industry's inquiry into "Energy Policy – Security of Supply".

The response looked at how Government policy could balance the competing needs of security of supply, environmental impact, national competitiveness and social concerns, arguing that security of supply was the most important target as none of the others could be achieved without it. It argued that security of supply was attainable through diversity of both primary fuel and sources, stressing that over reliance on a single source, such as Russian natural gas, had associated political risks.

http://www.raeng.org.uk/news/publications/submissions/pdfs/Energy_Policy_Security_of_Supply.pdf

TOWARDS A EUROPEAN STRATEGY FOR THE SECURITY OF ENERGY SUPPLY, NOVEMBER 2001

The Academy's response to the European Commission's Green Paper on Security of Supply.

In the context of Europe as a whole, similar issues apply to security of supply as The Academy argued for the UK in "Energy Policy – Security of Supply", but issues surrounding the European supply networks rose to the fore. In essence, because of its island status and geographical position, the UK is at the extremities of the European supply networks and is therefore more susceptible to interruption of supply than Member States which are more central. Similar problems can be envisaged for the Iberian Peninsula. Difficulties in establishing truly open markets for energy across the EU were also cited as potential problems, as well as differing tax regimes making the establishment of Europe wide financial instruments difficult.

http://www.raeng.org.uk/news/publications/submissions/pdfs/EC_Green_Paper.pdf

AN ENGINEERING APPRAISAL OF THE PERFORMANCE AND INNOVATION UNIT'S ENERGY REVIEW, AUGUST 2002

The Academy was invited by Mr Brian Wilson MP, Minister of State for Energy and Industry to provide him with an engineering appraisal of the PIU's Energy Review. At the time, some criticism had been raised against the PIU's Energy Review as being driven by economic and market considerations with little concern as to what could physically be delivered by industry.

The appraisal was conducted by the Academy's Energy Working Group under the chairmanship of Dr Malcolm Kennedy CBE FREng and made wide-ranging recommendations for the implementation of such policies. It also raised concerns about reliance on wind energy to meet renewable targets due to grid integration and stability issues which were further complicated by wind generators' random intermittency. While the PIU Review avoided saying anything concrete about the future of nuclear generation, the appraisal highlighted the fact that nuclear generation did not emit greenhouse gasses and that as it was phased out, it would have to be replaced by other non-emitting sources on top of the current targets for renewable generation.

<http://www.raeng.org.uk/policy/pdfs/Energy%20v14.pdf>

STATE AID – RESTRUCTURING AID IN FAVOUR OF BRITISH ENERGY PLC, AUGUST 2003

This response was for the European Commission and addressed an EC call for views concerning the recent granting of State Aid by the UK Government to British Energy Plc. While, on the face of it, this might be interpreted as a purely financial or political issue, there were strong engineering issues behind it.

The Academy's response, while acknowledging the political element of the situation, stated that the generating capacity of British Energy's plant was required to maintain capacity margins in the UK electricity system and that the UK Government was therefore justified in granting state aid in the first instance, to ensure that they were not taken off-line. In the event of all of British Energy's plant being withdrawn without notice, the security of electricity supplies for the whole of the UK would have been put at risk. A number of serious large-scale blackouts around the world recently have demonstrated the vulnerability of electricity systems to cascade failures, what ever the proximate cause of that failure might be. Lack of adequate generating capacity margin, over and above demand, would have made containing such an event very much more difficult for the grid operator, National Grid Transco.

<http://www.raeng.org.uk/policy/pdfs/Response%20v5.pdf>

RESPONSE TO THE HOUSE OF LORDS SCIENCE AND TECHNOLOGY SELECT COMMITTEE INQUIRY INTO THE PRACTICALITIES OF DEVELOPING RENEWABLE ENERGY, OCTOBER 2003

The Academy recently responded to the House of Lords Science and Technology Select Committee's Inquiry into "The Practicalities of Developing Renewable Energy". When the Government's White Paper on energy, "Our energy future – creating a low carbon economy" was published earlier this year, The Academy felt that the targets it set for renewable electricity generation were laudable but ambitious. The House of Lords Science and Technology Committee was concerned that there would be difficulty in meeting the targets. Because of the importance of meeting these targets and the large number of stakeholders involved, the Academy's main recommendation was that the Government should publish an annual report on progress towards the targets, specifying the costs involved to protect security of supply and the subsidies required.

The Academy's response also examined the prospects for the main renewable energy technologies currently available and looked at their economics. In reality, no renewable technology, not even on-shore wind, could compete with modern gas powered CCGT plant on a level playing field and all had to be subsidised to some extent through the Renewables Obligation. However, some serious questions had been raised concerning how the Renewables Obligation Certificates (ROCs) system worked. Because ROCs were tradable, their price could fluctuate, thus, the subsidy that a renewable electricity generator could expect to receive also varied. With volatility in gas prices as well, the financial risk of investing in renewable technologies was currently more than any but firms with very large balance sheets could bear. Consequently, there were serious financial barriers as well as solid engineering barriers to the development of renewable electricity generation in the UK.

<http://www.raeng.org.uk/policy/pdfs/ResponseV3.pdf>

The Royal Academy of Engineering

The objectives of The Royal Academy of Engineering are to pursue, encourage and maintain excellence in the whole field of engineering in order to promote the advancement of the science, art and practice of engineering for the benefit of the public.

The Academy comprises the United Kingdom's most eminent engineers of all disciplines. It is able to take advantage of their wealth of knowledge and experience which, with the interdisciplinary character of the membership, provides a unique resource with which to meet the objectives.

Its activities include an extensive education programme, research chairs and fellowships, visiting professorships, industrial secondments and international travel grants. It provides expert advice on engineering matters to government and other bodies and awards the UK's premier annual prize for innovation in engineering, The Royal Academy of Engineering MacRobert Award.

Election to The Academy is by invitation only. Up to sixty Fellows may be elected annually, together with Honorary Fellows and Foreign Members who have made exceptional contributions to engineering. All are elected by their peers for personal achievement of exceptional merit and distinction. Fellows are distinguished by the title "Fellow of The Royal Academy of Engineering" and use the designatory letters "FREng".

The Academy was founded in 1976 as The Fellowship of Engineering on the initiative of HRH The Duke of Edinburgh and a group of distinguished engineers. It was granted its Royal Charter in 1983 and, with the consent of HM The Queen, adopted the present title in 1992.

The Royal Academy of Engineering

29 Great Peter Street, Westminster, London, SW1P 3LW

Telephone 020 7227 0500 Facsimile 020 7233 0054

www.raeng.org.uk



ROYAL
ACADEMY
of
ENGINEERING

The Cost of Generating Electricity

A COMMENTARY

on a study carried out by PB Power for
The Royal Academy of Engineering



Costs of Generating Electricity

Commentary by the Royal Academy of Engineering

The Royal Academy of Engineering commissioned PB Power to conduct a study of the comparative costs of generating electricity from a number of available technologies. The full results of that study are contained in the Academy's report "Costs of Generating Electricity" and this document serves as both an Executive Summary and as a Commentary on the work performed by PB Power.

Introduction

In order to make sensible decisions about energy policy for the UK, policy makers need to be able to compare the costs and benefits of different types of electricity generating technologies on a like for like basis. Unfortunately, the UK electricity market is complex. The relationship between the cost of generating electrical power from various sources and the price that consumers pay is blurred by direct and indirect subsidies, market mechanisms, transmission and distribution costs. The true costs of generating electrical power are often obscured by commercial sensitivities and competing claims that make the determination of sensible energy policy difficult and often imprecise.

The Royal Academy of Engineering has taken a keen interest in energy policy and has often been concerned about the lack of clarity between competing claims over what is the best mix of generation and how the electricity market should be manipulated to achieve the aims of the Government's current energy policy. To help improve understanding, the Academy has attempted to compare the costs of generating electricity from a number of different technologies in an even-handed and dispassionate manner and commissioned PB Power to carry out a study. The results of the study are contained in the Academy's report, *The Costs of Generating Electricity*.

The complex financial structures of commercial projects mean that it is often impossible to compare the capital costs of generating plant in a meaningful manner. This study has taken what we know to be the actual costs of building, maintaining and running various types of power station in the UK and derived costs of producing electricity by using a common financing model with a nominal discount rate of 7.5%. It compares new build power stations on a level playing field and examines their sensitivities to emissions costs and fuel prices. The figures presented here are therefore indicative rather than predictive. However, unlike many other compilations of costs, they compare like with like and therefore will be of immense use to policy makers.

Scope

The objective of this study is to provide decision makers with simple, soundly based indicators of the cost performance for alternative electricity generation technologies. The scope required a certain amount of simplification and approximation of issues that would be of utmost importance to a commercial organisation making an investment decision in the electricity generation market. These include treatment of risk and uncertainty, security of supply of fuel and project financial structures as well as market and regulation issues. The Academy believes that a more comprehensive treatment would be of value to policy makers.

The complexities of the UK electricity market also mean that there are a large number of non-trivial, variable costs that are not specific to the technologies used to generate electricity. These all have a bearing on the price that the consumer eventually pays, but as these costs are often spread across the whole market as system operating costs, they were therefore excluded from this study. Further examination of these system costs, especially the impact of transmission costs, could also prove valuable.

Results

The study examined a number of different technologies listed below.

- Coal plant
 - Pulverised fuel (PF) steam plant;
 - Circulating fluidized-bed combustion (CFBC) plant;
 - Integrated gasification combined-cycle (IGCC) plant;
- Gas plant
 - Open-cycle gas turbine (OCGT) plant;
 - Combined-cycle gas turbine (CCGT) plant;
- Nuclear fission plant.
- Biomass (poultry litter)
 - Bubbling fluidized-bed combustion (BFBC) plant;
- Wind turbines
 - Onshore
 - Offshore
- Wave and Marine

The PB Power report arrived at the following results:-

The cost of generating electricity, as defined within the scope of this study, is expressed in terms of a unit cost (pence per kWh) delivered at the boundary of the power station site. This cost value, therefore, includes the capital cost¹ of the generating plant and equipment; the cost of fuel burned (if applicable); and the cost of operating and maintaining the plant in keeping with UK best practices. Within the study, however, the ‘cost of generating electricity’ is deemed to refer to that of providing a dependable (or ‘firm’) supply. For intermittent² sources of generation, such as wind, an additional amount has been included for the provision of adequate standby generation. The findings of this study are summarised in Figure 1, which illustrates the present-day costs of generating electricity from different types of technology appropriate to the UK:

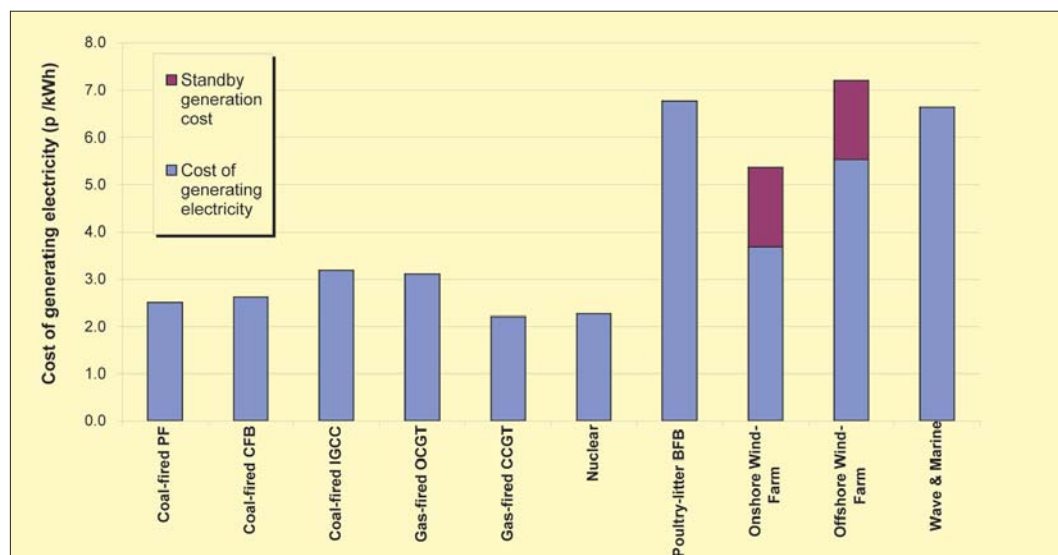

Figure 1 Cost of generating electricity (pence per kWh) with no cost of CO2 emissions included.

¹ With the exception of nuclear, the analysis assumes that decommissioning is cost neutral. The capital cost estimate for nuclear plant includes an allowance for the costs of decommissioning.

² For the purpose of this study, wave and marine technologies are deemed to be predictable and therefore have not been burdened with the additional cost of standby generation.

For base-load operation, i.e. those plants which are operated continuously, the cheapest way to generate electricity in the future from new plant, i.e. ignoring rehabilitation of existing plant, is by constructing combined-cycle gas turbine (CCGT) plant designed to burn natural gas.

Table 1 summarises the cost of generating electricity for the different 'base-load' plants considered by this study.

Gas-fired CCGT	2.2
Nuclear fission plant	2.3
Coal-fired pulverised-fuel (PF) steam plant	2.5
Coal-fired circulating fluidized bed (CFB) steam plant	2.6
Coal-fired integrated gasification combined cycle (IGCC)	3.2

Table 1 Cost of generating electricity for base-load plant (pence per kWh)

For peaking operation, i.e. generating for limited periods of high demand and providing standby capacity, open-cycle gas turbines (OCGT) fired on natural gas are the most appropriate new plant candidates. OCGT is ideally suited for the role of peaking duty, which requires flexibility, reliability and can be started quickly should the need arise. We estimate that the cost of a gas-fired OCGT generation will be about 3.1 pence per kWh if operated continuously. However, the average cost will rise to about 6.2 pence per kWh if only operated for limited periods of time consistent with peaking duty, i.e. for only 15 per cent of the time, say.

Renewables are generally more expensive than conventional generation technologies. This is due in part to the immaturity of the technology and the more limited opportunity to take advantage of cost savings brought about by economies of scale usually associated with more traditional fossil-fuel types of generation. In addition, fluctuations in the energy source itself may limit the output of generation available from these technologies and, thus, raise the unit costs of the generator on two counts:

- as capacity factor³ falls, unit costs of generation rise;
- additional, fast response, standby generating plant may have to be provided to maintain system security as the energy source fluctuates.

³ 'capacity factor' is an operational term to represent the extent to which the generator is producing electricity over a period, e.g. a year. Wind turbines have typical capacity factors of 25-45 per cent whilst large coal or nuclear plants may have capacity factors in excess of 90 per cent when operating on base-load.

Table 2 summarises the cost of generating electricity, with and without the additional cost of standby generation, from the selection of renewable technologies considered by this study.

	Without standby generation	With standby generation
Poultry litter-fired bubbling fluidized bed (BFB) steam plant	6.8	6.8
Onshore wind farm	3.7	5.4
Offshore wind farm	5.5	7.2
Wave and marine technologies ⁴	6.6	6.6

Table 2 Cost of generating electricity for selected renewables (pence per kWh)

Although the fuel component of electricity may represent as much as 70 per cent of the total cost of production, deriving a detailed forecast of future fuel prices was outwith the scope of this study. In order to compare the costs of different fuels used in electricity generation, we have taken a pragmatic view of historical prices and the key drivers affecting fuel prices moving forward to derive reasonable benchmarks from which to perform sensitivity analyses.

Figure 2 illustrates the effect on the cost of generating electricity given a change of ±20 per cent in fuel price, where the base cost of coal is £30 per tonne and natural gas is 23 pence per therm.

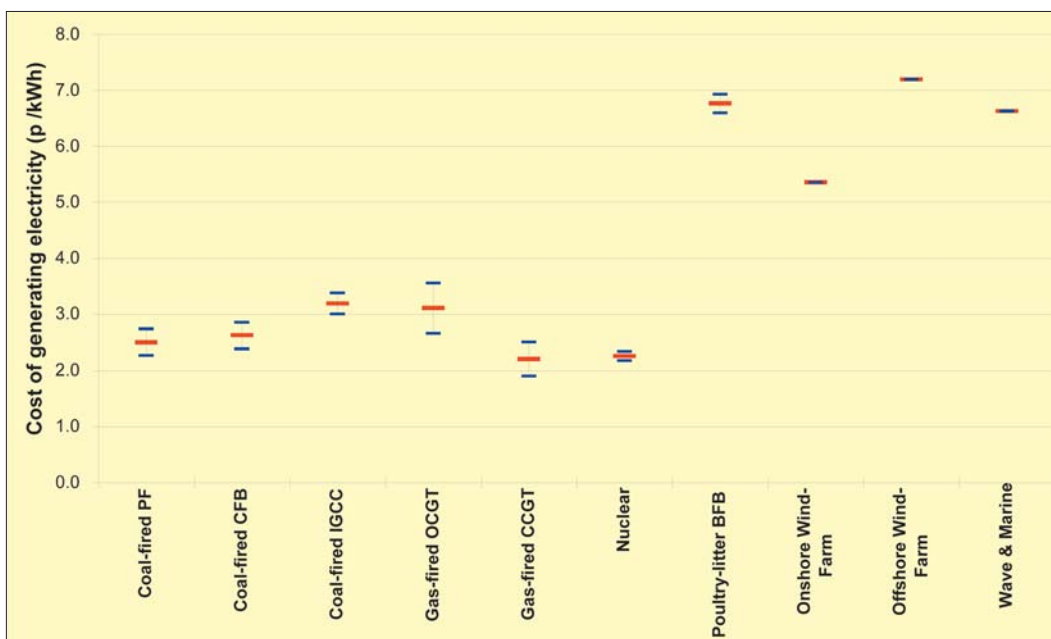

Figure 2 Effect of ± 20% change in fuel price on the cost of generating electricity

⁴ The additional cost of standby generation for wave and marine technologies has not been included because only low levels of penetration are expected within the study horizon.

At the time of writing this report, no firm commitment has been given by the Government on how carbon dioxide (CO₂) emission allowances will be allocated to new entrant generation plant for the period 2005 to 2007. In view of this uncertainty, a conservative approach has been adopted by the study to burden 100 per cent of the output from fossil fuelled generation with a notional cost, calculated in terms of £ per tonne of CO₂ released. For the purposes of this study, a range of values between zero and £30 per tonne was used, where the upper limit reflects the reported cost of CO₂ sequestration.

Figure 3 illustrates the potential increase in generating costs brought about by the introduction of carbon emission allowances.

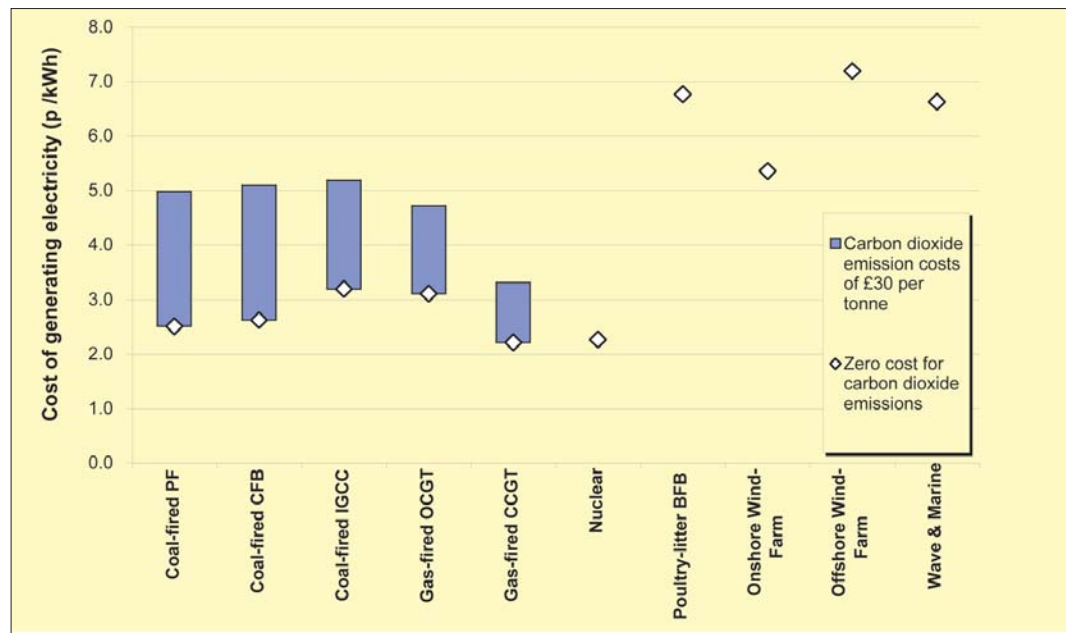

Figure 3 Cost of generating electricity with respect to carbon dioxide emission costs. (Zero to £30 per tonne)

It is clear that CO₂ costs will only affect those technologies burning fossil-fuels. The lower efficiency of steam plant, combined with the greater level of carbon found in coal compared with natural gas, means that the gap between CCGT plant and other coal-fired technologies will widen as the cost of CO₂ increase. The cost of nuclear and other renewables (deemed to be carbon neutral) remain unchanged and, therefore, become more competitive as the specific cost of CO₂ emissions increases.

Conclusions

The issues to be addressed when considering an energy policy include: security of supply, environmental impact, national competitiveness and social concerns. Each technology examined in this study has its own set of characteristics that are valued to more or lesser extents depending on the context and which have a bearing on four issues above. Hence, the mix of generation cannot and should not be determined solely by cost, but a rigorous understanding of those costs will enable policy makers to understand the levels of subsidy or market manipulation that is required to give a desired outcome. Furthermore, those market mechanisms and subsidies should relate directly to the particular form of generation and the perceived benefit rather than being smoothed across the system, giving rise to cross subsidies.

The renewables sector already benefits from subsidies worth in the region of £485 million a year through the Renewables Obligation and concern has been expressed⁵ that Government plans to offer further subsidies (e.g. reductions in transmission charges), through amendments to the Electricity Bill, will not lead to extra investment. This may also run counter to the spirit of the new European Electricity Directive aimed at promoting competitive energy markets and could be regarded as further distortions to the market.

This examination of the costs of generating electricity is a foundation upon which discussion about future energy policy including subsidies and market mechanisms can be based.

Critical Issues

This study has highlighted some areas where better understanding of comparative costs would be useful in the formation of energy policy:

1. While this study provides a set of comparative figures for the costs of generating electricity, a number of factors have been simplified and certain assumptions made. This study should be built upon and the methodology refined to include other issues that influence the decisions of commercial operators in the electricity generation market.
2. A number of elements of the cost of electricity are hidden or shared throughout the system rather than allocated to specific generators. These are balancing costs and transmission costs which also deserve further examination
3. Further scrutiny of the commercial claims for nuclear power would be useful because of the lack of data from existing new-build projects
4. The variability of prices for emissions and Renewable Obligation Certificates introduces a level of risk into financing both renewable and conventional plant.
5. Security of supply of electrical power has recently been raised as significant issue by some commentators. Further study of the risks to secure fuel supplies (particularly natural gas) and transmission system stability would usefully add to the debate at a policy level.
6. Policy makers could derive significant value from regular updates of this study and further work into the costs of electricity transmission and distribution, in particular the costs of reinforcement and re-engineering that the grid and distribution systems will require to support the Government's targets for renewable generation.

⁵ *Ofgem press release, 13 February 2004,*
http://www.ofgem.gov.uk/temp/ofgem/cache/cmsattach/5915_r1404_13feb.pdf

The Royal Academy of Engineering

The objectives of The Royal Academy of Engineering are to pursue, encourage and maintain excellence in the whole field of engineering in order to promote the advancement of the science, art and practice of engineering for the benefit of the public.

The Academy comprises the United Kingdom's most eminent engineers of all disciplines. It is able to take advantage of their wealth of knowledge and experience which, with the interdisciplinary character of the membership, provides a unique resource with which to meet the objectives.

Its activities include an extensive education programme, research chairs and fellowships, visiting professorships, industrial secondments and international travel grants. It provides expert advice on engineering matters to government and other bodies and awards the UK's premier annual prize for innovation in engineering, The Royal Academy of Engineering MacRobert Award.

Election to The Academy is by invitation only. Up to sixty Fellows may be elected annually, together with Honorary Fellows and Foreign Members who have made exceptional contributions to engineering. All are elected by their peers for personal achievement of exceptional merit and distinction. Fellows are distinguished by the title "Fellow of The Royal Academy of Engineering" and use the designatory letters "FREng".

The Academy was founded in 1976 as The Fellowship of Engineering on the initiative of HRH The Duke of Edinburgh and a group of distinguished engineers. It was granted its Royal Charter in 1983 and, with the consent of HM The Queen, adopted the present title in 1992.

The Royal Academy of Engineering

29 Great Peter Street, Westminster, London, SW1P 3LW

Telephone 020 7227 0500 Facsimile 020 7233 0054

www.raeng.org.uk